



Section 1 ***Introduction***

Welcome Aboard

Dear Formula Owner:

Welcome aboard! We appreciate how much careful thought, research and planning you put into the decision to purchase a new boat, and we are pleased to welcome you as a new member of the Formula family.

Members of the Formula team – your local dealership’s personnel as well as all the Formula employees who had a part in building, inspecting and providing support for your boat – are dedicated to delivering the highest quality product possible, and we all share in your pride of ownership.

Your Formula boat will afford you many hours of relaxation and pleasure on the water. Along with the enjoyment, however, comes responsibility for not only yourself but also your passengers and others on the water. This Owner Information Manual is designed to help you familiarize yourself with your new Formula before you take her out on the water and as a quick-reference tool whenever a little information is needed. Your selling dealer will also be glad to help you learn more about your new boat should any questions arise.

We also encourage you, and all those who will be boating with you, to take a safe boating course. The United States Coast Guard Auxiliary, the United States Power Squadron, and the American Red Cross all offer free courses. Call 1-800-336-BOAT for information on the boating course nearest you (in Virginia, call 1-800-245-BOAT). The more you know about boating, the more fun you will have!

Congratulations on your wise decision. We wish many satisfying hours of boating pleasure to you and your crew!

Sincerely,

Scott D. Porter
President

SUN SPORT

NMMA Certification

Formula is a charter member of the National Marine Manufacturers Association (NMMA). This independent organization members include boat, engine and marine equipment manufacturers that are focused on the improvement and safety of boating.

Your new Formula boat is NMMA certified. A NMMA certification not only satisfies the U. S. Coast Guard (USCG) regulations but also the more rigorous equipment and system standards based on those established by the American Boat and Yacht Council, Inc. (ABYC). Your Formula meets or exceeds NMMA safety-based certifications.



Yacht Certification

Figure 1-1

FOR191

DECLARATION OF CONFORMITY

A **CE mark** means the boat complies with European directives for recreational vessels as published by the International Organization for Standardization (ISO).

TABLE OF CONTENTS

Section 1—Introduction

Declaration of Conformity	1-2
Table of Contents	1-3
Owner/Operator Responsibilities	1-5
Publications	1-5
Qualified Boat Operators	1-5
Education Opportunities.....	1-5
Federal, State and Local Regulations	1-6
Reporting Accidents	1-6
Rendering Assistance	1-6
Serial Number Locations.....	1-6
Repair and Modifications	1-6
Environmental Considerations	1-7

Section 2—Boating Safety

Signal Words/Definitions	2-1
Required Safety Equipment.....	2-2
Recommended Equipment	2-5
Emergency Considerations.....	2-5
Hazardous Conditions.....	2-6
Operating By Minors	2-9
Communication	2-9

Section 3—Specifications and Layout

Boating Terminology.....	3-1
Dimensions.....	3-2
240 Bowrider	3-4
260 Bowrider	3-6
260 SunSport	3-8
280 Bowrider	3-10
280 SunSport	3-12
310 Bowrider	3-14
310 SunSport	3-16
330 SunSport	3-18
350 SunSport	3-20

Section 4—Controls and Indicators

Gauges	4-1
Switches	4-3
Circuit Breakers.....	4-7
Steering	4-8
Remote Controls	4-8
Helm Controls and Indicators	4-10
Cabin Controls and Indicators.....	4-11
Battery Selector Switches	4-15

Section 5—System Operation and Equipment

Powertrain	5-1
Fuel System	5-1
Helm System.....	5-1
Bilge and Blower System.....	5-2
DC Electrical.....	5-2
AC Electrical.....	5-3

Shore Power.....	5-5
Generator	5-7
Battery Charger.....	5-8
Inverter	5-9
Air Conditioning System.....	5-9
Fresh Water System	5-10
Gray Water System.....	5-11
Waste Water System.....	5-11
Raw Water System	5-13
Automatic Fire Extinguisher System.....	5-13
Equipment	5-14

Section 6—Getting Underway

Safety Checklist.....	6-1
Basic Safe Boating Rules	6-1
Fueling.....	6-4
Pre-Operational Checks.....	6-5
Boat Trim/Loading	6-6
Boarding	6-6

Section 7—Operation

Starting	7-1
Shifting.....	7-3
Steering	7-3
Running	7-3
Stopping	7-3
Engine Flushing	7-4
Operating at High Speed	7-5
Propeller Effect.....	7-6
Maneuvering Techniques	7-6
Boating At Night	7-8
Special Operating Conditions	7-8
Holding Position	7-8
Trimming-Drive Units and Trim Tabs	7-9
Anchoring and Sea Anchors	7-13
Towing and Being Towed	7-15
Heavy Weather	7-16
Swimming and Diving	7-18
Docking.....	7-19
Mooring Lines.....	7-20
Using Fenders.....	7-21
Navigational Hints	7-21

Section 8—Schedule Checks and Service

After Each Run.....	8-1
Scheduled Maintenance Checks	8-1

Section 9—Care and Maintenance

Interior Cleaning	9-1
Exterior Cleaning.....	9-2
Unscheduled Maintenance	9-4
Bilge.....	9-6
Corrosion and Electrolysis	9-6
Galvanic Corrosion Protection	9-7

SUN SPORT

Section 10—Storage

In-Water Storage Preparation	10-1
Lifting the Boat	10-1
Storage Cradle	10-2
Storage/Winterization	10-2
Re-activating the Boat After Storage	10-2

Section 11—Troubleshooting

Section 12—Warranty and Service

Year One	12-1
Years Two Through Five	12-1

Section 13—Forms

Service Log	13-1
Fuel Log	13-2
Float Plan	13-3
Useful Information	13-4
Transfer Form.....	13-5

OWNER/OPERATOR RESPONSIBILITIES

At the time of delivery, the owner/operator is responsible for:

- Understanding warranty terms and conditions of both the propulsion units and boat.
- Obtaining insurance.
- Examining boat to ensure proper operation of all systems.

Before operating the boat, the owner/operator is responsible for:

- Obtaining state registration of the boat.
- Providing the proper USCG required safety equipment.
- Following proper break-in procedure for the propulsion unit(s).
- Understanding safety information and proper operating procedures within this manual.

While operating the boat, the owner/operator is responsible for:

- Knowing that all safety equipment and personal floatation devices (PFDs) are in good condition and suitable for your boat and passenger load.
- Having at least one other passenger who is capable of handling the boat in an emergency.
- Following safe operating practices and the "Rules of the Road."
- Understanding proper maintenance and knowledge of the boat's operating systems.
- Providing safety training for the passengers.
- Avoiding the use of alcohol and other drugs.
- Providing assistance to other boaters.

Insurance

You must obtain insurance before operating your new boat. Insurance for loss by fire, theft or other causes, or liability protection against accidents is a must for responsible boaters. The boat owner is legally responsible for any damage or injury caused when he, or someone else operating the boat, is involved in an accident. Many states have laws detailing minimum insurance needs. Your insurance agent or your dealer may be able to supply you with more information.

Registration/Documentation

The USCG requires that all power boats operated on the navigable waters of the U. S. must be registered in the state of main use; also, many states require registration in that state whenever boating on waters within their state boundary. Contact your state boating authorities (and neighboring states) for registration information on boats and trailers. Your Formula dealer can supply you with the appropriate forms.

PUBLICATIONS

Your Owner Information Binder includes information about onboard systems and equipment furnished by suppliers other than Formula Boats. Please refer to these manufacturer's manuals for additional operation and maintenance instructions not covered in this manual.

QUALIFIED BOAT OPERATORS

This manual is not intended to provide complete training on all aspects of boat operation. We strongly recommend that all operators of this boat seek additional training on boat handling and safety. Have all operators become familiar with the handling characteristics, and proper steering and control system usage before attempting high-speed operation.

Some states require youths 16 years of age and younger to complete a boating safety course before operating any watercraft. Many others require operators under the age of 18 to be licensed in small boat operation.

EDUCATION OPPORTUNITIES

Boat smart from the start, take a boating safety course and get a free vessel safety check annually for your boat. For more information, contact: United States Coast Guard Auxiliary, 1-800-368-5647, www.cgaux.org; United States Power Squadrons, 1-888-FOR-USPS, www.usps.org.

SUN SPORT

Most boaters can enhance their enjoyment of boating experiences through increased knowledge of safe operation, navigation and regulation of pleasure boats. The following is a list of some other agencies and organizations that offer Water Safety, First Aid and CPR courses or information. To find boating safety courses in your area, call your state's local boating agency or the USCG boating safety courseline at 1-800-336-2628 (1-800-245-2628 in Virginia).

- American Red Cross
- State Boating Offices
- Canadian Power and Sail Squadrons
- Boat Owners Association of the United States
- National Safe Boating Council
- Yacht Clubs

FEDERAL, STATE AND LOCAL REGULATIONS

The USCG is the authority of the waterways; they are there to help the boating public. State boating regulations are enforced by local authorities. You are subject to marine traffic laws and "Rules of the Road" for both federal and state waterways; you must stop if signaled to do so by enforcement officers, and permit to be boarded as asked.

REPORTING ACCIDENTS

The USCG requires the owner or operator of a boat involved in an accident, to report the incident to the proper marine law enforcement agency for the state in which the accident occurred. Immediate notification to the nearest State boating authority is required if a person dies or disappears as a result of a recreational boating accident. If a person dies or sustains injuries requiring more than first aid, a formal report must be filed within 48 hours of the accident. A formal report must be filed within 10 days for accidents exceeding \$500 in property damage or complete loss of boat.

RENDERING ASSISTANCE

If you see a distress signal or suspect a boat is in trouble, you must assume it is a real emergency and render assistance immediately. By law, the operator in charge of the craft is obligated to provide assistance to any individual in danger if such assistance can be provided safely. Failure to render assistance can result in a fine and/or imprisonment.

The 1971 Boating Safety Act grants protection to a "Good Samaritan" boater providing good faith assistance, and absolves a boater from any civil liability arising from such assistance.

SERIAL NUMBER LOCATIONS

Your Formula boat, its engines and propulsion units, and other equipment onboard will have a serial number for identification. It is a good practice to prepare a list of all serial number items and store it in a safe place other than onboard the boat. An Important Information Form is located at the end of this manual. Please refer to the equipment operator's manuals supplied in your Owner Information Binder for location of serial numbers.

REPAIRS AND MODIFICATIONS

Your Formula boat has been designed for safety in the harsh marine environment and thoroughly tested and certified for compliance with applicable safety standards. Because of the possibility of interference with the structural design of the boat, owner installation of additional equipment or modifications of factory equipment is not recommended and may void manufacturer's warranties.

In addition, do not attempt to make repairs unless you are certified to do so. Be sure to have the necessary authorized repair information, and use approved marine replacement parts.

Your Formula dealer is qualified to ensure repairs, additions or modifications to your boat will not compromise safety, design integrity or warranty coverage.

ENVIRONMENTAL CONSIDERATIONS

As a boater, you already appreciate nature's beauty and the peace of the great outdoors. It is a boater's responsibility to protect the natural environment by keeping waterways clean.

MARPOL Treaty

The USCG enforces the International Convention for the Prevention of Pollution from ships, commonly referred to as the MARPOL Treaty (MARine POLLution). This treaty prohibits the overboard dumping of all ship-generated plastics, chemicals, garbage and oil.

Fuel/Oil Spillage

WARNING

Fumes from rags can collect in bilge and be extremely hazardous. Do not store rags used to wipe-up fuel or solvent spills in the boat. Dispose of rags properly ashore.

The spilling of fuel or oil into our waterways contaminates the environment and is dangerous to wildlife. Do not discharge or dispose of fuel, oil or other chemicals into the water; it is prohibited and you can be fined. These are two common, accidental types of discharge:

- Overfilling the fuel tanks
- Pumping contaminated bilge water

Discharge/Disposal of Waste

Waste means all forms of garbage, plastics, recyclables, food, wood, detergents, sewage, and even fish parts in certain waters – in short, nearly everything. We recommend you bring back everything you take out with you for proper disposal ashore.

Use an approved pump-out facility at your marina. Many areas prohibit the discharge of sewage overboard or even an operable overboard waste discharge.

Marine Sanitation

NOTICE

Direct disposal of sanitation waste into some waters is prohibited and could result in being fined. Be sure to check local regulations.

CAUTION

To avoid damaging the waste disposal system and the environment, do not place facial tissues, paper towels or sanitary napkins in the head.

Have your Formula dealer properly service the waste disposal system when needed.

Excessive Noise

Noise means engine noise, radio noise or even voices. Many bodies of water have adopted noise limits. Do not use thru-transom exhaust unless you're well off shore. Music and loud conversation can carry a considerable distance on water, especially at night. Be sure to follow regulations and be courteous.

Wake/Wash

WARNING

You are responsible for injury and damage caused by your wake/wash.

Be alert for NO WAKE zones. Prior to entering a no wake zone, come off plane to the slowest steerable speed. Use caution when operating around smaller crafts, in channels and marinas, and in congested areas.

Exhaust Emissions

Increased exhaust (hydrocarbon) emissions pollute our water and air. Keep your engine tuned and boat hull clean for peak performance. Consult your Formula dealer and propulsion unit operator's manual for information.

WARNING

The engine exhaust from this product contains chemicals known to the State of California to cause cancer, birth defects or other reproductive harm.

KCCPROP65G

Paints

If your boat is kept in water where marine growth is a problem, the use of anti-fouling paint may reduce the growth rate. Be aware of environmental regulations that may govern your paint choice. Contact your local boating authorities for information.

SUN SPORT

Cleaning Agents

Household cleaners should be used sparingly and not discharged into waterways. Do not mix cleaners and be sure to use plenty of ventilation in enclosed areas. DO NOT use products which contain phosphates, chlorine, solvents, non-biodegradable or petroleum based products. Citrus-based cleaners are excellent for marine cleaning purposes and are safe for you and the environment.

Fishery Resources

There is a tremendous drain on our fishery resources. Over-fishing and pollution have strained the fish population. Do your part by keeping only what you will eat and practice catch-and-release.

Foreign Species

If you trailer your boat from lake to lake, you may unknowingly introduce a foreign aquatic species from one lake to the next. Thoroughly clean the boat below the water line, remove all weeds and algae, and drain the bilge before launching the boat in a new body of water.



Section 2 Boating Safety

Your safety, the safety of your passengers, and other boaters are among your responsibilities as operator of this boat. Your boat must be in compliance with USCG safety equipment regulations. You should know how to react correctly to adverse weather conditions, have good navigation skills, and follow the “rules of the road” as defined by the USCG and state/county/local regulations.

WARNING

- **Read and understand this manual, the propulsion unit manual, and the generator manual. Be sure that you understand all controls and operating instructions before attempting to operate the boat. Improper operation can be extremely hazardous.**
- **Be in control of your boat. Do not operate your boat under the influence of alcohol or other drugs.**

Before each outing you should check all safety equipment, such as fire extinguishers, personal flotation devices (PFDs), flares, distress flags, flashlights, and the engine stop switch. They should be operable, in good condition, readily visible, and easily accessed.

Check local weather reports before casting off; do not leave the dock area when strong winds and electrical storms are in the area or predicted to be in the area.

Tell someone your travel plans and leave a float plan. A float plan makes the job of search and rescue much easier for authorities. A float plan template can be found in the back of this manual.

SIGNAL WORDS/ DEFINITIONS

The popularity of boating and other water sports has undergone an explosion in growth the past few years. Because of this, safety is an important issue for everyone who shares in the use of our waterways.

Throughout this manual specific precautions and symbols identify safety related information.

The Safety Alert Symbol means ATTENTION!
BECOME ALERT! YOUR SAFETY IS INVOLVED!



DANGER

Indicates the presence of a hazard which **WILL** cause **SEVERE** injury, death or substantial property damage.

WARNING

Indicates the presence of a hazard which **CAN** cause **SEVERE** injury, death or substantial property damage.

CAUTION

Indicates the presence of a hazard which **WILL** or **CAN** cause **MINOR** or **MODERATE** personal injury or property damage.

SUN SPORT

NOTICE

Indicates installation, operation or maintenance information which is important but not hazard-related.

The precautions listed in this manual and on your Formula boat are not all-inclusive. If a procedure, method, tool, or part is not specifically recommended, you must satisfy yourself that it is safe for you and others, and that the boat will not be damaged or made unsafe as a result of your decision. **REMEMBER-- USE COMMON SENSE WHEN OPERATING YOUR BOAT!**

REQUIRED SAFETY EQUIPMENT

The Federal Boat Safety Act of 1971 (FBSA/71) established minimum safety standards for boats and associated equipment, specified by the USCG. In addition, the ABYC and the NMMA work with boat builders to develop voluntary standards that exceed base requirements.

The included safety equipment on your Formula meets or exceeds the standards of the USCG, ABYC and the NMMA. Some required safety equipment such as PFDs are not included with your Formula boat. Your Formula dealer can help you choose the appropriate equipment.

NOTICE

Many states' equipment requirements go beyond USCG requirements. Contact your state boating office for further information.

Equipment requirements for coastal and inland waters differ. Check with local authorities or the USCG for further information about coastal water requirements.

The following equipment may or may not be required by federal/local regulations.

Life Saving Equipment

Federal law requires at least one Type I, II, III, or V Personal Flotation Device (PFD), of the proper size, for each person on board or being towed, and at least one Type IV throwable PFD in the boat.

There are four types of PFDs to wear and one type used for throwing in emergency situations.

Type I Life Preserver: Most buoyant PFDs are effective on all waters, especially open, rough water.



KC-0041

**Type I
Life Preservers
Figure 2-1**

Type II Buoyant Vest: Good for calm water near shore on most inland waters where quick rescue is likely.

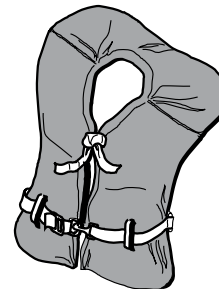

KC-0051

**Type II
Buoyant Vests
Figure 2-2**

Type III Flotation Aid: Good for most inland water applications where quick rescue is likely. Comes in various styles and some are designed for water sport activities.



KC-0042

**Type III
Flotation Aids
Figure 2-3**

BOATING SAFETY

Type V Hybrid PFD: Inflatable design for special use activities. May be used instead of a Type I, II, or III PFD if used in accordance with the approval conditions on the label and if worn when the boat is underway. Some Type V PFDs provide increased protection against hypothermia.

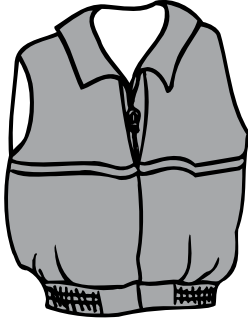

KC-0043

**Type V
Hybrid PFD
Must Be Worn
When Underway
Figure 2-4**

- **A Type V PFD must be worn to be counted toward the minimum carriage requirements.**
- **Special PFDs are available for skiing and other water sports. These PFDs are constructed with materials suitable for high impact falls.**

PFDs are intended to help save lives. The operator should set an example by wearing one. Wear a PFD whenever boating. It is especially important that children and non-swimmers wear a PFD at all times. Make certain all passengers know how to put on and properly adjust their PFDs. Also, selecting the proper type PFD for your kind of outing helps ensure your time on the water can be the safest possible.

At the beginning of each season, check PFDs for damage and test for proper flotation. Refer to the PFD manufacturer's information.

All boats over 16 feet (4.8 meters) in length must carry one USCG approved Type IV throwable lifesaving device, such as a ring buoy or buoyant cushion. To meet requirements, each lifesaving device must have a current, legible USCG approval stamp permanently affixed.

Type IV Throwable Device: Intended for heavy traffic inland waters where help is available. Designed to be thrown to a person in the water and should never be worn.

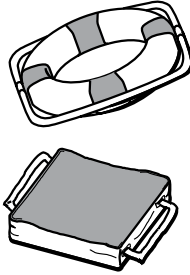

KC-0071

**Type IV
Throwable Devices
Figure 2-5**

Your Formula dealer can help you select appropriate PFDs and throwable lifesaving devices for your area.

Navigation Lights

All power boats underway between sunset and sunrise must display proper navigation lights. All boats at anchor must display a proper anchor light. The anchor light must be visible 360 degrees. Your Formula boat is equipped with international navigation lights.

Horn or Whistle

All boats over 4.8 meters (16 feet) in length must be equipped with an operable horn or whistle, audible from one mile. Your Formula boat is equipped with a USCG approved horn.

Fire Extinguisher

All boats must carry an appropriate portable marine type B (gasoline, oil or grease) fire extinguisher in operable condition and in an accessible location. Your Formula boat is equipped with two portable and a fixed system fire extinguisher. All passengers should know the location and operating procedure of each extinguisher.

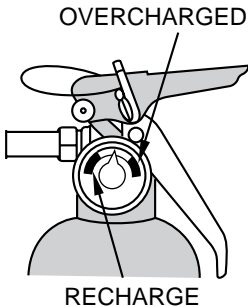

KC-0083

**Portable Fire Extinguisher
Figure 2-6**

SUN SPORT

Check the pressure gauge regularly for proper pressure; have the extinguisher filled if necessary.

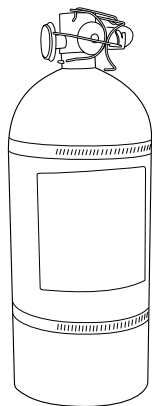

FOR021

Fixed Automatic Fire Extinguisher
Figure 2-7

A fixed automatic fire extinguisher is mounted on the engine compartment forward bulkhead. The extinguisher is activated when the heat sensitive head reaches a predetermined temperature. The extinguisher discharges and saturates the engine compartment, smothering the fire. For additional information, refer to **Halon Automatic Fire Extinguisher, Section 5.**

Visual Distress Signals







All boats over 16 feet (4.8 meters) must have onboard day and night visual distress signals when operating on coastal waters, the Great Lakes, territorial seas or those waters directly connected to them, up to a point where the body of water is less than two miles wide. Carry several types of signaling devices to handle a variety of conditions. Your Formula dealer can help you select appropriate visual distress signals for your area.

If you are required to carry distress signals, you must have three USCG approved pyrotechnic devices. Be sure they are in serviceable condition, not exceeding the expiration date and stored in a cool, dry location in a waterproof container. Have enough signals on board to last three days.

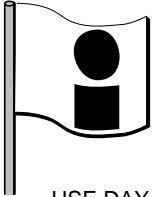
⚠ WARNING

Pyrotechnic signaling devices can cause injury and property damage if improperly handled. Follow the manufacturer's directions.

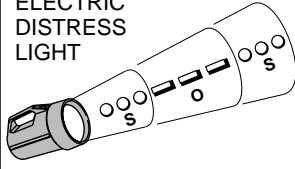
VISUAL DISTRESS SIGNALS

 <p>ORANGE FLAG</p> <p>USE DAY ONLY</p>	<p>RED DISTRESS FLARE (HAND)</p>  <p>USE DAY AND NIGHT</p>
 <p>ARMS SIGNALS (USE BRIGHT CLOTH)</p> <p>USE DAY ONLY</p>	<p>USE DAY ONLY</p>  <p>ORANGE SMOKE SIGNAL (HAND)</p>
<p>ELECTRIC DISTRESS LIGHT</p>  <p>USE NIGHT ONLY</p>	<p>RED METEOR FLARE</p>  <p>USE DAY AND NIGHT</p> <p>DYE MARKER</p>  <p>USE DAY ONLY</p>

KC-0082

Visual Distress Signals
Figure 2-8

RECOMMENDED EQUIPMENT

In spite of all efforts to the contrary, problems or mishaps sometime occur while boating. Stock these items listed below on your boat to help make unexpected events more manageable.

- Sea anchor and anchor line
- Life raft
- Tow line
- Mooring lines and fenders
- Compass
- First aid kit and manual
- Day/night distress signals
- Radar reflector
- Flashlight and spare batteries
- Cellular phone
- Binoculars
- Portable AM/FM radio with weather band
- Emergency Position Indicating Radio Beacon (EPIRB)
- Engine, drive unit and trim tab lubricant
- Tool kit
- Spare propeller and mounting hardware
- Spare fuses and bulbs
- Boat hook
- Spare keys
- Sun glasses and sun block lotion
- Bottled water

Sea Anchors

You should have a separate sea anchor onboard to slow drifting. In heavy seas, a sea anchor is set from the bow to control the boat's behavior. The sea anchor holds the bow to the sea and a slow drift. Please consult your Formula dealer for sea anchor recommendations.

Life Raft

If operating offshore, you should consider carrying an inflatable life raft. A USCG approved life raft meets a number of stringent specifications. The life raft must be large enough to hold all the boat's occupants and have its own equipment pack including a paddle.

EMERGENCY CONSIDERATIONS

Be prepared to deal with emergencies before they happen. Try to formulate a plan for each type in advance so that decisions can be made quickly and without hesitation. Precious moments lost can mean the difference between losing and saving a life.

Fire/Explosion

You must be prepared and act quickly when dealing with a fire. It is not recommended to battle a fire for an extended period of time. Turn engines off and abandon the boat if the fire cannot be extinguished quickly. Swim at least 25 yards (23 meters) upwind from the boat and use the visual distress signals to get assistance.

WARNING

Gasoline will float on top of water and can burn. If the boat is abandoned, swim up wind, far enough to avoid fuel that may spread over the surface of the water.

Onboard fires involving the fuel system usually result in either an explosion that completely destroys the boat, or the boat burning to the waterline and self-extinguishing. Deciding on abandoning the boat or staying to fight the fire is difficult and depends on many factors. Try to formulate a fire plan in advance to make that decision quickly and without hesitation.

Be sure to:

- Use caution and do not smoke when refueling.
- Verify that fuel does not leak.
- Use only marine approved equipment on your boat.

SUN SPORT

Flooding/Swamping

Improper loading, handling, water conditions, weather and anchoring are the most common causes of flooding. Insist on a safe, stable load. Do not operate the boat exceeding your ability to maneuver it. Use extreme caution in hazardous weather and rough water conditions. Anchor from the bow when using one anchor.

Collisions/Leaks

If a collision occurs, immediately account for all passengers. Assess the hull for damage and activate the bilge pumps to reduce any water intake. Try to operate the boat to keep the damaged area above water. If necessary, call or signal for assistance.

If a leak is discovered, immediately determine the cause. A collision with an underwater object could cause the hull to develop a leak. A loose fitting or hose clamp on a piece of equipment could cause a leak. Try to repair the leak if possible. If a leak is threatening the safety of you and your passengers, call or signal for assistance.

Grounding

In the event you run aground, assess the situation before proceeding. Immediately stop any water from entering the boat. Inspect the propulsion units, steering and control systems, and the hull for damage. Maneuver the boat to safe water only if the hull and all operating systems are in satisfactory operating condition. Otherwise, call or signal for assistance.

Water Rescue (Man Overboard)

Immediately react to a person who has fallen overboard. Keep the victim constantly in your sight. Safely return to the victim as soon as possible. Throw the person a life preserver. Turn off the engines and help the person into the boat.

Medical Emergency

Be prepared in the event of an emergency. Know how to use your first aid kit. Be aware of any special medical conditions of your passengers.

Drowning

React to a drowning victim the same as described in Water Rescue. Handle the victim with care. They could be injured. If necessary, resuscitate the victim. Immediately signal for help and keep the victim warm.

Operation Failure

If you experience a propulsion, steering or control failure, immediately turn off the engines. Set the anchor if possible or release a sea anchor to prevent drifting. Try to determine the failure and repair, if possible. Otherwise, call or signal for assistance.

HAZARDOUS CONDITIONS

Every waterway poses hazards that you should avoid, such as shallow water, tree stumps and sand bars. Ask local boaters for information and consult a marine chart when boating on unfamiliar waters. As the operator of the boat, you should try to avoid all hazards, known and unknown. The following information does not contain all possible water hazards.

Operating in shallow water presents a number of hazards. Mud, sand, weeds and debris can foul a propulsion unit propeller or its cooling water. If a propulsion unit strikes an underwater object, check the propulsion unit and boat for damage. If a vibration is noticed after striking an object, it may indicate a damaged propeller.

Sand bars in narrow inlets are constantly shifting, making it difficult to mark them with buoys. Tides in coastal areas affect water levels producing sand bars. Sometimes sand bars are indicated by waves as they form into breakers when passing over the sand bar. Refer to **Grounding**, in this section, if you run aground on a sand bar.

The water level around a dam spillway is a hazardous area. It is subject to rapid changes caused by currents and turbulence. Keep clear of the spillway areas below dams.

Visibility

WARNING

Clear visibility must be maintained at all times. If necessary, arrange passengers and equipment for maximum visibility. Designate a passenger to assist when visibility is limited due to operating conditions.

Visibility is not only sight, but also hearing. It is very important the operator maintains good visibility at all times. Arrange passengers and equipment to ensure you have unobstructed vision at all times. Check for other boats or any obstacles before turning the boat.

BOATING SAFETY

Drugs/Alcohol

⚠ WARNING

Federal and state law prohibit operating a boat under the influence of alcohol and other drugs. These regulations are actively enforced. Impaired operation may result in severe personal injury or death.

Mixing boating with the use of alcohol and other drugs results in many marine accidents and deaths each year. These substances reduce your reaction time and affect your better judgement. Combined with the sun, wind, waves, and noise of other watercraft, the effects of drugs are increased and will significantly reduce your reaction time. As the owner/operator, you are responsible for the alcohol/drug use and onboard behavior of your passengers.



KC-0153

No Alcohol or Other Drugs
Figure 2-9

NOTICE

If the operator's blood alcohol content is 0.10% (0.08% in some states) or above, violators are subject to a civil penalty up to \$1,000.00 or criminal penalty up to \$5,000.00, one year imprisonment or both. Operating a boat under the influence can also result in a loss of automobile driving privileges.

Carbon Monoxide



KC-5032

Carbon Monoxide Safety Symbol
Figure 2-10

⚠ WARNING

Test the carbon monoxide detectors operation before each trip, at least once a week and after the boat has been in storage. Do not tamper with the operation of the carbon monoxide detectors. They are installed for your safety.

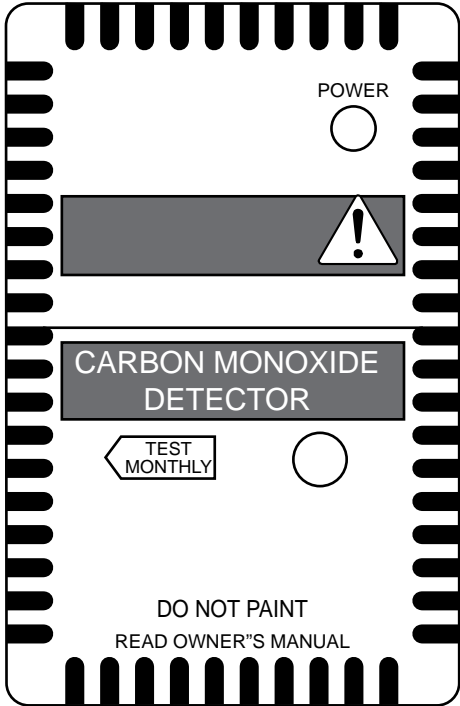

FOR069

Carbon Monoxide Detector
Figure 2-11

Your Formula boat is equipped with at least one carbon monoxide (CO) detector located in the V-berth.

CAUTION

A carbon monoxide (CO) detector will only detect the presence of carbon monoxide gas at its sensor. Carbon monoxide may be present in other areas.

NOTICE

A carbon monoxide detector will not detect other vapors such as gasoline.

SUN SPORT

Carbon Monoxide (CO) is a colorless and odorless gas produced by all engines and fuel burning appliances such as heaters, stoves and generators. Even with the best boat design and construction, plus the utmost care in inspection, operation, and maintenance, hazardous levels of CO may still be present in accommodation spaces under certain conditions. Dizziness, ears ringing, headaches, nausea, unconsciousness and cherry red skin color are symptoms of carbon monoxide poison.

To reduce CO accumulation:

- Ventilate the boat interior by opening the deck hatches, windows and cabin door to provide adequate ventilation.

- Do not operate the engines or generator with the canvas installed.
- Only operate fuel burning appliances in well-ventilated areas.
- Avoid idling or using the generator while at idle for extended periods.
- Regularly inspect the engine and generator exhaust system for proper operation.
- Do not use any fuel burning appliances with a transom exhaust port when swimming from the stern swim platform.





Have a suspected CO victim deeply breathe fresh air and immediately seek medical attention.



DANGER

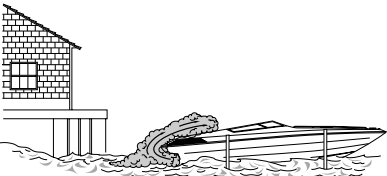
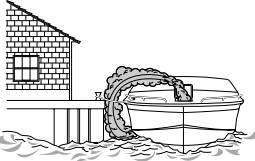

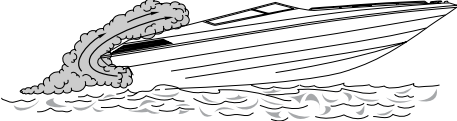
EXTREME HAZARD — Carbon monoxide gas (CO) is colorless, odorless and extremely dangerous. All engines and fuel burning appliances produce CO as exhaust. Direct and prolonged exposure to CO will cause BRAIN DAMAGE or DEATH. Signs of exposure to CO include nausea, dizziness and drowsiness. Sources of CO include:

<p>❶ Blockage of boat exhausts by obstruction.</p> 	<p>❷ Exhaust traveling along obstruction.</p> 
<p>❸ Operating at slow speed or while dead in the water.</p> 	<p>❹ Operating with high bow angle.</p> 
<p>❺ Exhausts from other vessels in confined areas.</p> 	
<p>❻ Operating with canvas tops and side curtains in place without ventilation.</p> 	

ENSURE ADEQUATE VENTILATION FOR CORRECT AIR MOVEMENT THROUGH BOAT!

FOR050

Carbon Monoxide
Figure 2-12

Fume Alarm

Your Formula boat is equipped with a fume detector that provides an audible and visual alarm whenever explosive gases are detected in the bilge area.

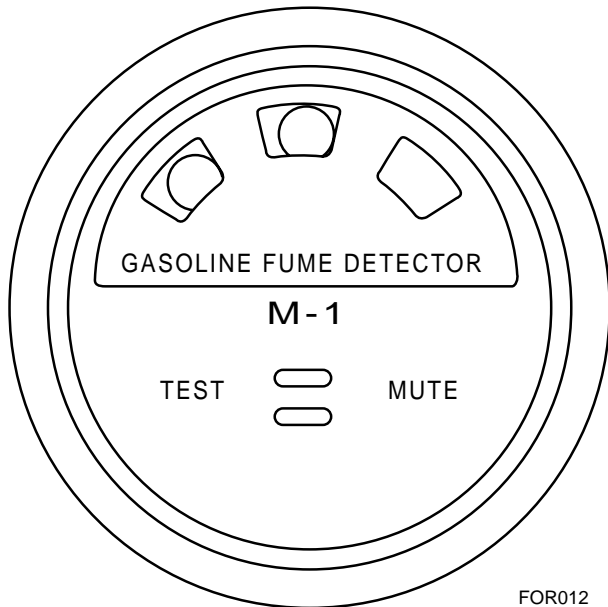

Fume Detector
Figure 2-13

In the event the detector goes into the alarm mode, immediately operate the engine compartment blowers and inspect for the source of fumes.

For testing procedure and additional information, refer to the fume detector instructions in your Owner Information Binder.

OPERATING BY MINORS

Minors must be supervised by an adult whenever operating a boat. Many states have laws regarding the minimum age and licensing requirements of minors. Be sure to contact the state boating authorities for information.

COMMUNICATION

Radio communication is the most important avenue of receiving weather reports and Coast Guard warnings, and for transmitting information such as a request for assistance. Use a VHF/FM radio for short-range communication, and a single-sideband radio (SSB) for long-range.

For all U. S. waters, the National Weather Service operates the NOAA Weather Radio (NWR). This service provides continuous weather information on the following VHF/FM frequencies:

- 162.400 MHz
- 162.425 MHz
- 162.450 MHz
- 162.475 MHz
- 162.500 MHz
- 162.525 MHz
- 162.550 MHz

It is good practice to periodically monitor the weather. For additional information, refer to your radio operator's manual in your Owner Information Binder.

A distress call is transmitted on VHF/FM radio channel 16 (156.800 MHz) or 2182 kHz (SSB). Know your audible signals:

- For emergency, the call sign is "Mayday."
- An urgent situation, the call sign is "Pan-Pan."
- For navigational safety and weather warnings, the call sign is "Security."

Repeat the call sign three times.

Immediately react to a distress call. Assist, if possible, using an emergency frequency. Otherwise continue to monitor the situation until help has arrived.

Cellular Telephone

A cellular phone can be extremely convenient. Cellular telephone service continues to improve by expanding service areas and advancing technology.

Seek the latest available information regarding network providers in your boating area before purchasing cellular telephone service.

SUN SPORT

Emergency Position Indicating Radio Beacon (EPIRB)

Every boat that goes offshore beyond the 20 mile VHF radio range should carry a satellite EPIRB.

The latest satellite EPIRBs are known as 406 EPIRB. The operating frequency is 406.0 MHz. This is a dedicated frequency free from interference from other communications. When activated, the satellite 406 EPIRB transmits a unique registration number for identification. The system detects a signal, checks the registration number against a database (boat and owner information), calculates an accurate distress position and quickly alerts rescue personnel.

Warning Label Location

Your boat has various safety labels at the time of manufacture. These labels appear at specific locations on the craft where safety is of particular concern.

Safety labels must remain legible. If you suspect a label is missing or becomes damaged, please contact your Formula dealer for immediate replacement.

NOTICE

Included in your Owner Information Binder is a label regarding the discharge of overboard trash. Thunderbird Products does not affix this label to the boat. It is the owner's/operator's responsibility to read, understand, and comply with the label's requirements.

BOATING SAFETY

Warning Label Location

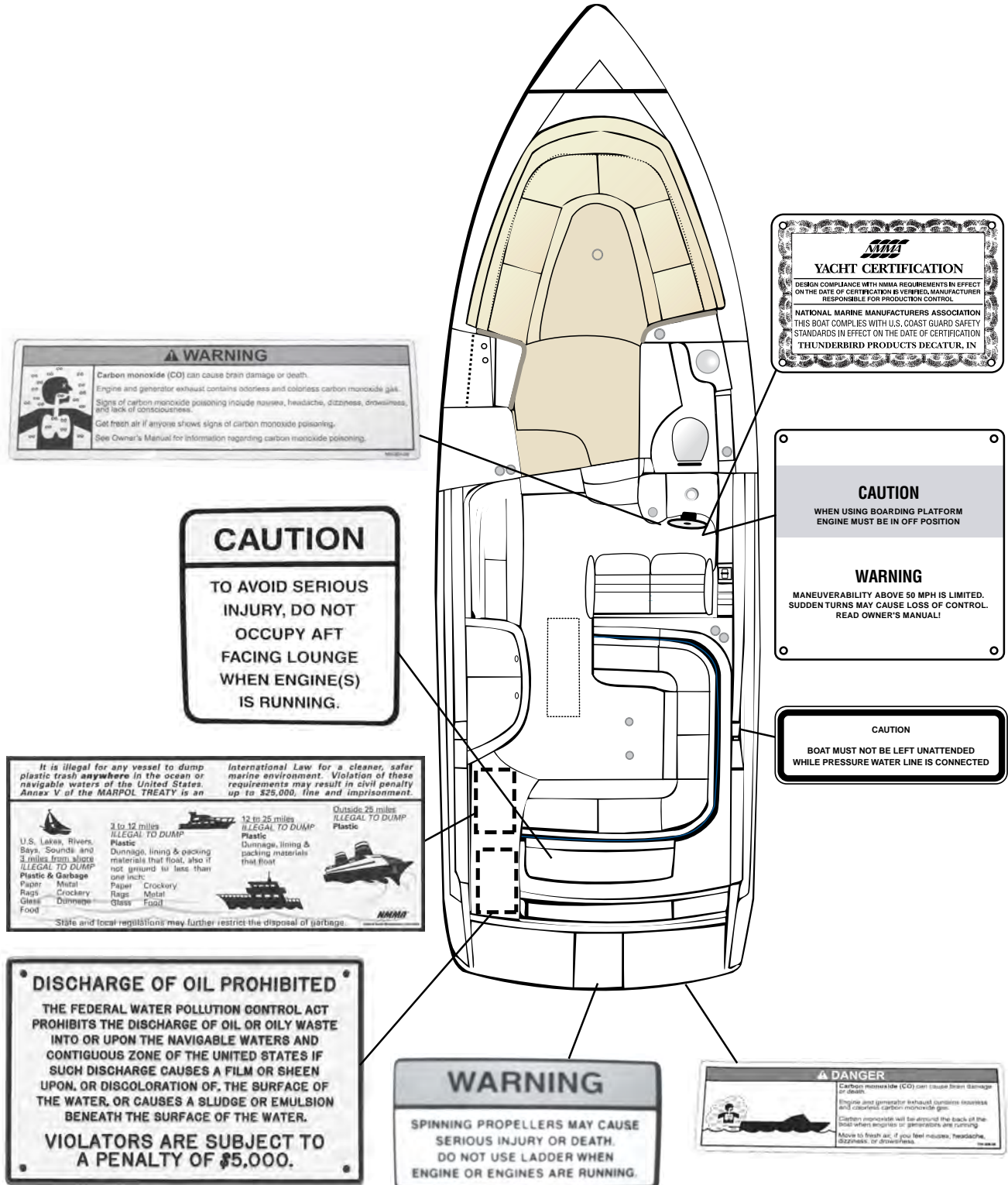

FOR261

Warning Label Location
Figure 2-14

SUN SPORT



Section 3 Specifications and Layout

BOATING TERMINOLOGY

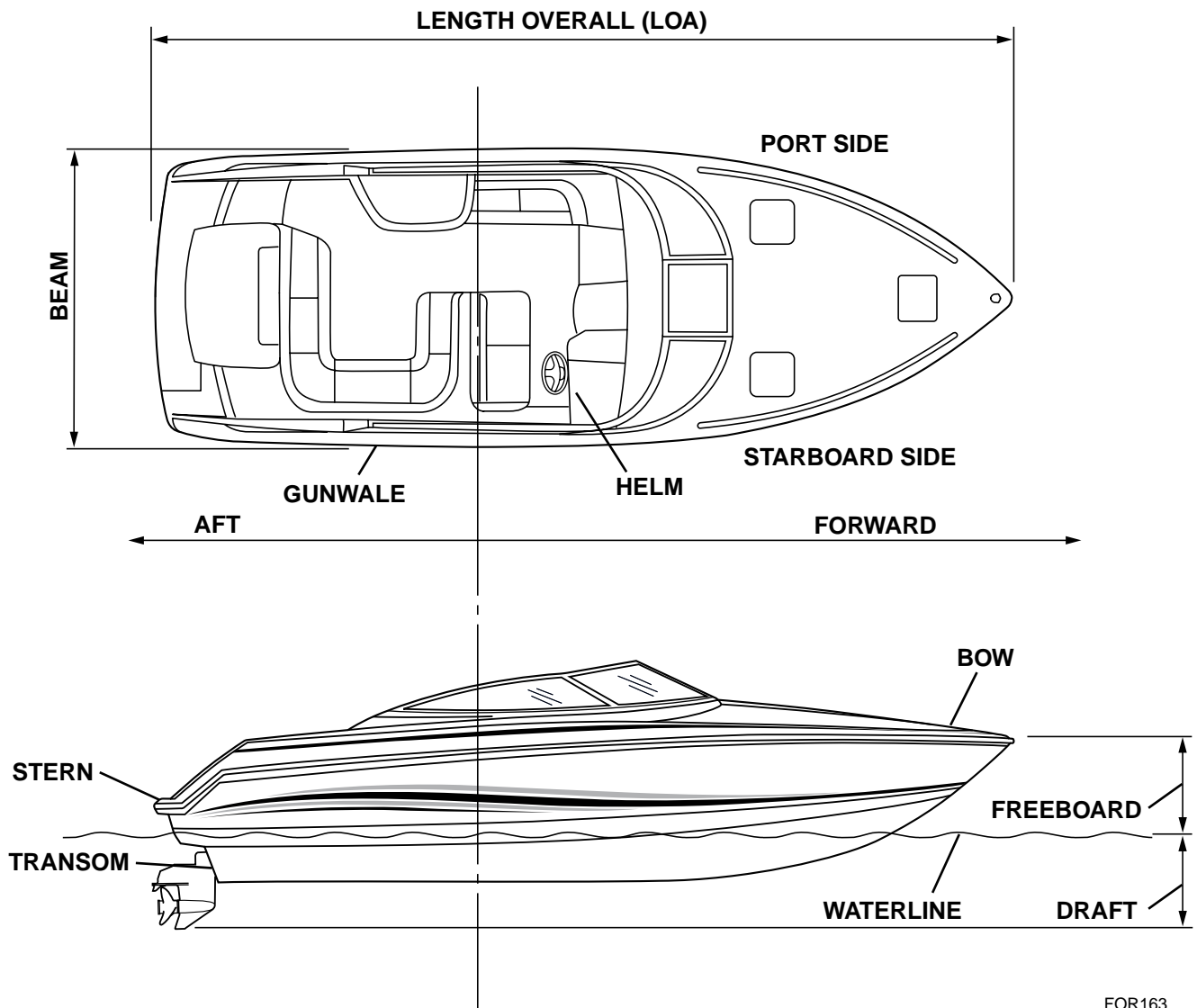

FOR163

* An easy way to remember PORT side from STARBOARD side is "PORT" and "LEFT" both have four letters.

SUN SPORT

DIMENSIONS

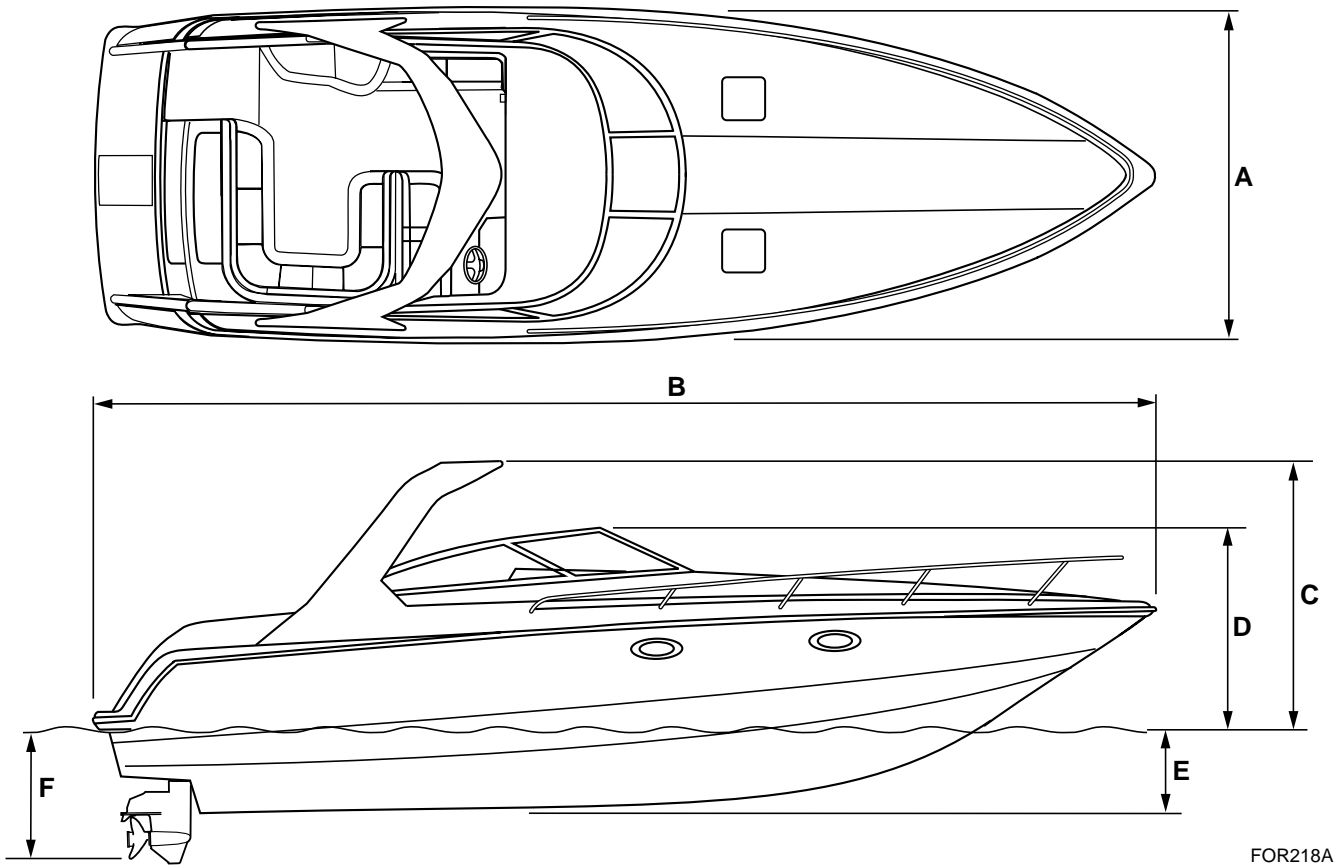

SPECIFICATIONS AND LAYOUT

		240 BR	260 BR	260 SS	280 BR	280 SS	310 BR	310 SS	330 SS	350 SS
A	Maximum Beam	8'6" (2.59 m)	8'6" (2.59 m)	8'6" (2.59 m)	9'2" (2.79 m)	9'2" (2.79 m)	9'6" (2.9 m)	9'6" (2.9 m)	10'2" (3.1 m)	10'9" (3.28 m)
B	Length Overall (LOA)	24'0" (7.32 m)	28'0" (8.53 m)	28'0" (8.53 m)	29'6" (8.99 m)	29'6" (8.99 m)	31'0" (9.45 m)	31'0" (9.45 m)	34'5" (10.5 m)	35'0" (10.67 m)
C	Bridge Clearance w/Arch (Dry)	7'5" (2.26 m)	8'3" (2.51 m)	8'3" (2.51 m)	8'6" (2.59 m)	8'6" (2.59 m)	8'7" (2.62 m)	8'8" (2.64 m)	9'0" (2.74 m)	9'5" (2.87 m)
D	Bridge Clearance w/o Arch (Dry)	4'8" (1.42 m)	5'0" (1.52 m)	5'0" (1.52 m)	5'8" (1.72 m)	5'8" (1.72 m)	6'1" (1.85 m)	6'1" (1.85 m)	6'0" (1.83 m)	6'10" (2.08 m)
E	Draft - Drive in TRAILER Position	26" (0.66 m)	20" (0.51 m)	20" (0.51 m)	24" (0.61 m)	24" (0.61 m)	27" (0.69 m)	27" (0.69 m)	23" (0.58 m)	29" (0.74 m)
F	Draft - Drive in Full DOWN position ¹	36" (0.91 m)	32" (0.81 m)	32" (0.81 m)	36" (0.91 m)	36" (0.91 m)	39" (0.99 m)	39" (0.99 m)	35" (0.89 m)	40" (1.02 m)
G	Dead Rise ²	20°	22°	22°	21°	21°	22°	22°	20°	21°

Note ¹. These figures will increase when equipment, people, and fuel are added.

Note ². Dead rise drawing not shown.

SUN SPORT

240 BOWRIDER

Specifications

Approximate Weight 5,000 Lbs. (2,268 Kg)

Capacities:

Fuel Tank	60 Gal. (227 L)
Fresh Water Tank	10 Gal. (37.9 L)
Holding Tank	10 Gal. (37.9 L)
Battery Charger	N/A

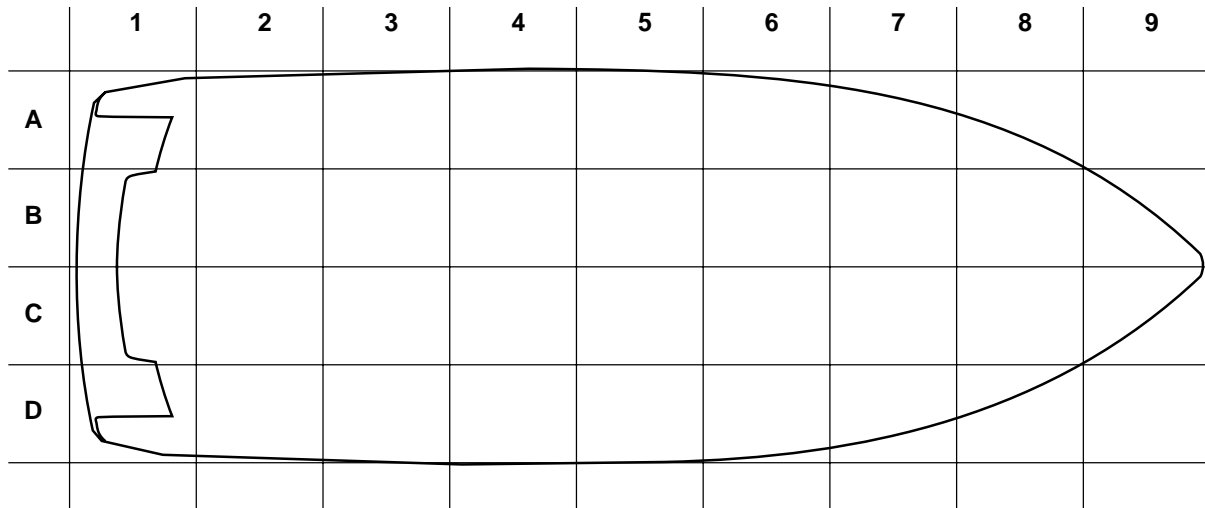

FOR165

240 BR Equipment Location

Item	Location	Remarks
AC Control Panel	N/A	
Air Conditioning Control	N/A	
Automatic Fire Extinguisher	B-3	FWD engine bulkhead
Battery – Auxiliary Battery*	C-2	Outboard of engine (PORT side)
Battery – Port Start	B-2	Outboard of engine (STBD side)
Battery – Starboard Start	N/A	
Battery Charger	N/A	
Battery ON/OFF Switch	D-4	Beneath cockpit wetbar
Battery Parallel Switch*	D-4	Beneath cockpit wetbar
Bilge Pump AFT	B/C-3	Keel/FWD of motor
Bilge Pump FWD	N/A	
Black Water Holding Tank*	C-5	Walk-thru floor storage area
Carbon Monoxide Detector	A-5	Head Unit
Circuit Breaker Panel – Helm	D-4	Helm
Circuit Breaker Panel – Aft	D-4	Beneath cockpit wetbar
Circuit Breaker – Shore Power 1	N/A	
Circuit Breaker – Shore Power 2	N/A	
Circuit Breaker – Windlass	N/A	
Circuit Breaker – Auxiliary Power	D-4	Beneath cockpit wetbar
DC Control Panel	N/A	
Drive Unit Trim Pump – PORT	A-2	Outboard of engine (PORT side)
Drive Unit Trim Pump – STBD	N/A	
Engine Compartment Blowers	A-2	Outboard of engine (PORT side)
Engine Compartment Hatch Handle	A-2	Engine hatch storage compartment

*Optional

SPECIFICATIONS AND LAYOUT

240 BR Equipment Location

Item	Location	Remarks
Engine Compartment Switch	C-5	Helm
Fire Extinguisher – Cabin	N/A	
Fire Extinguisher – Cockpit	D-4	Beneath cockpit wetbar
Fresh Water Fill	D-5	STBD deck
Fresh Water Dockside Hookup	N/A	
Fresh Water Level Indicator	N/A	
Fresh Water Pump	D-6	Helm storage area/behind aft wall
Fresh Water Tank	B-5	Walk-thru floor storage area
Fuel Tank Fill – PORT	N/A	
Fuel Tank Fill – STBD	D-2	STBD deck
Galvanic Isolator Monitor	N/A	
Generator	N/A	
Gray Water Holding Tank*	C-5	Black water holding tank
Gray Water Manifold	N/A	
Gray Water Sump Tank	N/A	
Horn Air Compressor	N/A	
Hull Identification Number	D-1	AFT STBD corner below rub rail
Hydraulic Steering Fill (Helm)	N/A	
Inverter	N/A	
iPod Cradle	N/A	
Macerator Y-Valve*	A-2	PORT hull side
Outdrive Switch (Transom)	A-1	PORT deck wall/swim platform
Seacock – Air Conditioning Intake	N/A	
Seacock – Generator Intake	N/A	
Seacock – Macerator Discharge*	B-2	FWD of motor
Seacock – Manual Head Intake*	B-2	FWD of motor
Seacock – Raw Water Engine Intake*	B/C-3	FWD of motor
Shore Power Hook-Up	N/A	
Ski Pylon*	A-2	Engine hatch storage compartment
Spotlight Control	N/A	
Stereo Amplifier*	D-5	Helm storage area
Stereo Auxiliary Input	C-5	Helm
Stereo CD Changer	N/A	
Stereo Control – Transom	D-1	STBD deck wall/swim platform
Stereo Control – Helm	C-5	Helm
Stereo Receiver	D-6	Helm storage area
Strainer – Air Conditioning Intake	N/A	
Strainer – Generator Intake	N/A	
Strainer – Raw Water Engine Intake*	B/C-3	FWD of motor
Telephone Jack	N/A	
Telephone/TV Dockside Inlet	N/A	
Transom Shower	D-2	STBD deck wall/swim platform
Trim Tab Pump	D-2	STBD hull side
TV Antenna Amplifier	N/A	
TV Antenna/Cable Switch	N/A	
Waste Deck Plate*	A-1	PORT deck wall/swim platform
Waste Tank Indicator*	A-5	Head compartment
Waste Vacuum Generator	N/A	
Water Heater	N/A	
Wiper Access	D-5	Helm storage area

*Optional

SUN SPORT

260 BOWRIDER

Specifications

Approximate Weight 6,300 Lbs. (2,858 Kg)

Capacities:

Fuel Tank 92 Gal. (348 L)
 Fresh Water Tank 14 Gal. (53 L)
 Holding Tank 2.6 Gal. Std./18 Gal. Opt. (9.8 L Std./68 L Opt.)
 Battery Charger N/A

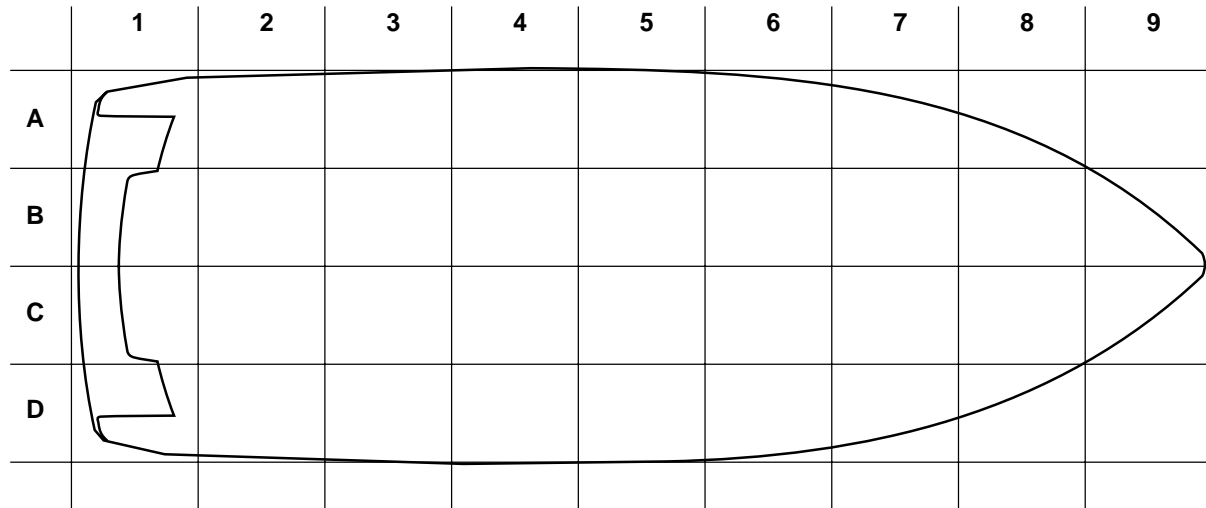

FOR165

260 BR Equipment Location

Item	Location	Remarks
AC Control Panel	N/A	
Air Conditioning Control	N/A	
Automatic Fire Extinguisher	B-2	FWD of motor – PORT side
Battery – Auxiliary Battery	A-2	Outboard of engine (PORT side)
Battery – Port Start	A-2	Outboard of engine (STBD side)
Battery – Starboard Start	N/A	
Battery Charger	N/A	
Battery ON/OFF Switch	A-3	Beneath cockpit wetbar
Battery Parallel Switch	A-3	Beneath cockpit wetbar
Bilge Pump AFT	B/C-2	Keel/FWD of motor
Bilge Pump FWD	D-6	STBD helm storage area
Black Water Holding Tank*	C-3/4	Above fuel tank
Carbon Monoxide Detector	A-6	Head Unit
Circuit Breaker Panel – Helm	D-5	Helm
Circuit Breaker Panel – Aft	A-3	Beneath cockpit wetbar
Circuit Breaker – Shore Power 1	N/A	
Circuit Breaker – Shore Power 2	N/A	
Circuit Breaker – Windlass	N/A	
Circuit Breaker – Auxiliary Power	A-3	Beneath cockpit wetbar
DC Control Panel	N/A	
Drive Unit Trim Pump – PORT	N/A	
Drive Unit Trim Pump – STBD	D-1	Outboard of engine (STBD side)
Engine Compartment Blowers	B-1	Transom
Engine Compartment Hatch Handle	N/A	

*Optional

SPECIFICATIONS AND LAYOUT

260 BR Equipment Location

Item	Location	Remarks
Engine Compartment Switch	C-5	Helm
Fire Extinguisher – Cabin	N/A	
Fire Extinguisher – Cockpit	A-3	Beneath cockpit wetbar
Fresh Water Fill	D-5	STBD deck side/beneath windshield wing
Fresh Water Dockside Hookup	N/A	
Fresh Water Level Indicator	N/A	
Fresh Water Pump	A-2	PORT hull side
Fresh Water Tank	D-6	STBD deck side/beneath windshield wing
Fuel Tank Fill – PORT	N/A	
Fuel Tank Fill – STBD	D-2	PORT deck side
Galvanic Isolator Monitor	N/A	
Generator	N/A	
Gray Water Holding Tank*	C-3/4	Above fuel tank (black water holding tank)
Gray Water Manifold	N/A	
Gray Water Sump Tank	N/A	
Horn Air Compressor	A-3	Cockpit wetbar
Hull Identification Number	D-1	AFT STBD corner below rub rail
Hydraulic Steering Fill (Helm)	N/A	
Inverter	N/A	
iPod Cradle	N/A	
Macerator Y-Valve*	D-2	STBD hull side
Outdrive Switch (Transom)	A-1	PORT deck wall/swim platform
Seacock – Air Conditioning Intake	N/A	
Seacock – Generator Intake	N/A	
Seacock – Macerator Discharge*	B/C-2	FWD of motor
Seacock – Manual Head Intake*	B/C-2	FWD of motor
Seacock – Raw Water Engine Intake*	B/C-2	FWD of motor
Shore Power Hook-Up	N/A	
Ski Pylon*	D-3	Aft cockpit – STBD side seat storage
Spotlight Control	N/A	
Stereo Amplifier*	D-6	STBD helm storage area
Stereo Auxiliary Input	D-5	Helm
Stereo CD Changer	N/A	
Stereo Control – Transom	A-1	PORT deck wall/swim platform
Stereo Control – Helm	N/A	
Stereo Receiver	C-5	Helm
Strainer – Air Conditioning Intake	N/A	
Strainer – Generator Intake	N/A	
Strainer – Raw Water Engine Intake*	B/C-2	FWD of motor
Telephone Jack	N/A	
Telephone/TV Dockside Inlet	N/A	
Transom Shower	A-1	PORT deck wall/swim platform
Trim Tab Pump	D-2	STBD hull side
TV Antenna Amplifier	N/A	
TV Antenna/Cable Switch	N/A	
Waste Deck Plate*	D-1	STBD deck wall/swim platform
Waste Tank Indicator*	A-6	Head
Waste Vacuum Generator*	D-2	Outboard of engine (STBD side)
Water Heater	N/A	
Wiper Access	D-6	STBD helm storage area

*Optional

SUN SPORT

260 SUN SPORT

Specifications

Approximate Weight (single/twin) 6,300 Lbs. (2,858 Kg)

Capacities:

Fuel Tank	92 Gal. (348 L)
Fresh Water Tank	14 Gal. (53 L)
Holding Tank	2.6 Gal. Std./18 Gal. Opt. (9.8 L Std./68 L Opt.)
Battery Charger	N/A

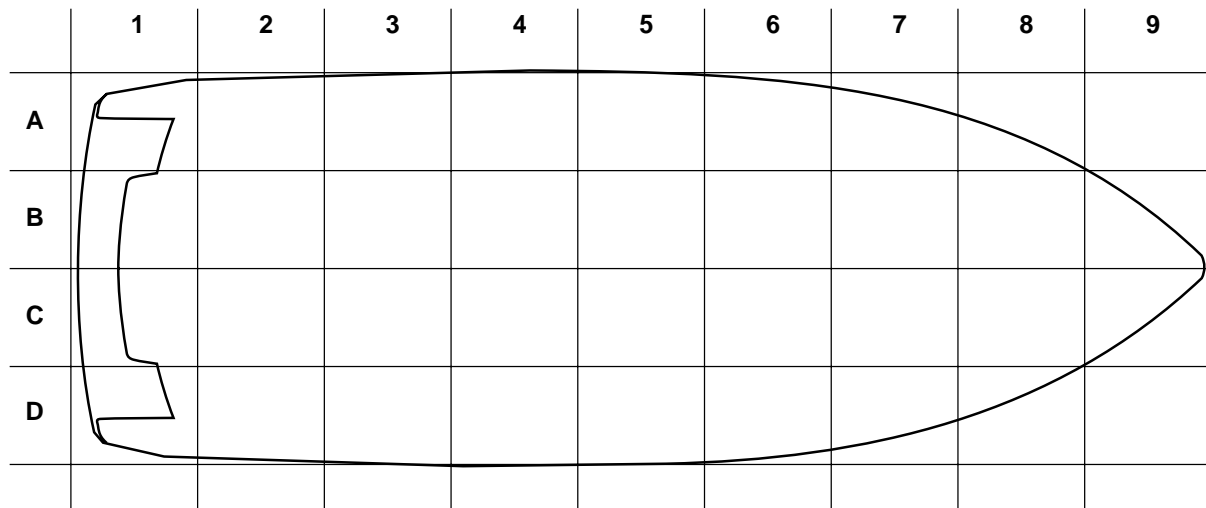

FOR165

260 SS Equipment Location

Item	Location	Remarks
AC Control Panel	N/A	
Air Conditioning Control	N/A	
Automatic Fire Extinguisher	B-2	FWD of motor – PORT side
Battery – Auxiliary Battery	A-2	Outboard of engine (PORT side)
Battery – Port Start	A-2	Outboard of engine (PORT side)
Battery – Starboard Start	N/A	
Battery Charger	N/A	
Battery ON/OFF Switch	A-3	Beneath cockpit wetbar
Battery Parallel Switch	A-3	Beneath cockpit wetbar
Bilge Pump AFT	B/C-2	Keel/FWD of motor
Bilge Pump FWD	N/A	
Black Water Holding Tank*	C-3/4	Above fuel tank
Carbon Monoxide Detector	A-6	Cabin entry wall
Circuit Breaker Panel – Helm	D-5	Helm
Circuit Breaker Panel – Aft	A-3	Beneath cockpit wetbar
Circuit Breaker – Shore Power 1	N/A	
Circuit Breaker – Shore Power 2	N/A	
Circuit Breaker – Windlass	N/A	
Circuit Breaker – Auxiliary Power	A-3	Beneath cockpit wetbar
DC Control Panel	N/A	
Drive Unit Trim Pump – PORT	N/A	
Drive Unit Trim Pump – STBD	D-1	
Engine Compartment Blowers	B-1	Outboard of engine (STBD side)
Engine Compartment Hatch Handle	N/A	Transom

*Optional

SPECIFICATIONS AND LAYOUT

260 SS Equipment Location

Item	Location	Remarks
Engine Compartment Switch	C-5	Helm
Fire Extinguisher – Cabin	N/A	
Fire Extinguisher – Cockpit	A-3	Beneath cockpit wetbar
Fresh Water Fill	D-5	STBD deck side/beneath windshield wing
Fresh Water Dockside Hookup	N/A	
Fresh Water Level Indicator	N/A	
Fresh Water Pump	A-2	PORT hull side
Fresh Water Tank	D-6	STBD helm storage area
Fuel Tank Fill – PORT	N/A	
Fuel Tank Fill – STBD	D-2	PORT deck side
Galvanic Isolator Monitor	N/A	
Generator	N/A	
Gray Water Holding Tank*	C-3/4	Above fuel tank (black water holding tank)
Gray Water Manifold	N/A	
Gray Water Sump Tank	N/A	
Horn Air Compressor	A-3	Beneath cockpit wetbar
Hull Identification Number	D-1	AFT STBD corner below rub rail
Hydraulic Steering Fill (Helm)	N/A	
Inverter	N/A	
iPod Cradle	N/A	
Macerator Y-Valve*	D-2	STBD hull side
Outdrive Switch (Transom)	A-1	PORT deck wall/swim platform
Seacock – Air Conditioning Intake	N/A	
Seacock – Generator Intake	N/A	
Seacock – Macerator Discharge*	B/C-2	FWD of motor
Seacock – Manual Head Intake*	B/C-2	FWD of motor
Seacock – Raw Water Engine Intake*	B/C-2	FWD of motor
Shore Power Hook-Up	N/A	
Ski Pylon*	D-3	Aft cockpit – STBD side seat storage
Spotlight Control	N/A	
Stereo Amplifier*	D-5	Aft of head storage cabinet
Stereo Auxiliary Input	D-5	Helm
Stereo CD Changer	N/A	
Stereo Control – Transom	A-1	PORT deck wall/swim platform
Stereo Control – Helm	N/A	
Stereo Receiver	C-5	Helm
Strainer – Air Conditioning Intake	N/A	
Strainer – Generator Intake	N/A	
Strainer – Raw Water Engine Intake*	B/C-2	FWD of motor
Telephone Jack	N/A	
Telephone/TV Dockside Inlet	N/A	
Transom Shower	A-1	PORT deck wall/swim platform
Trim Tab Pump	D-2	STBD hull side
TV Antenna Amplifier	N/A	
TV Antenna/Cable Switch	N/A	
Waste Deck Plate	D-1	STBD deck wall/swim platform
Waste Tank Indicator*	A-6	Head
Waste Vacuum Generator*	D-2	Outboard of engine (STBD side)
Water Heater	N/A	
Wiper Access	D-6	STBD Helm storage area

*Optional

SUN SPORT

280 BOWRIDER

Specifications

Approximate Weight (single/twin) 7,300/8,200 Lbs. (3,311/3,719 Kg)

Capacities:

Fuel Tank	120 Gal. (454 L)
Fresh Water Tank	20 Gal. (76 L)
Holding Tank	2.6 Gal. Std./26 Gal. Opt. (9.84 L Std./68 L Opt.)
Battery Charger	50A

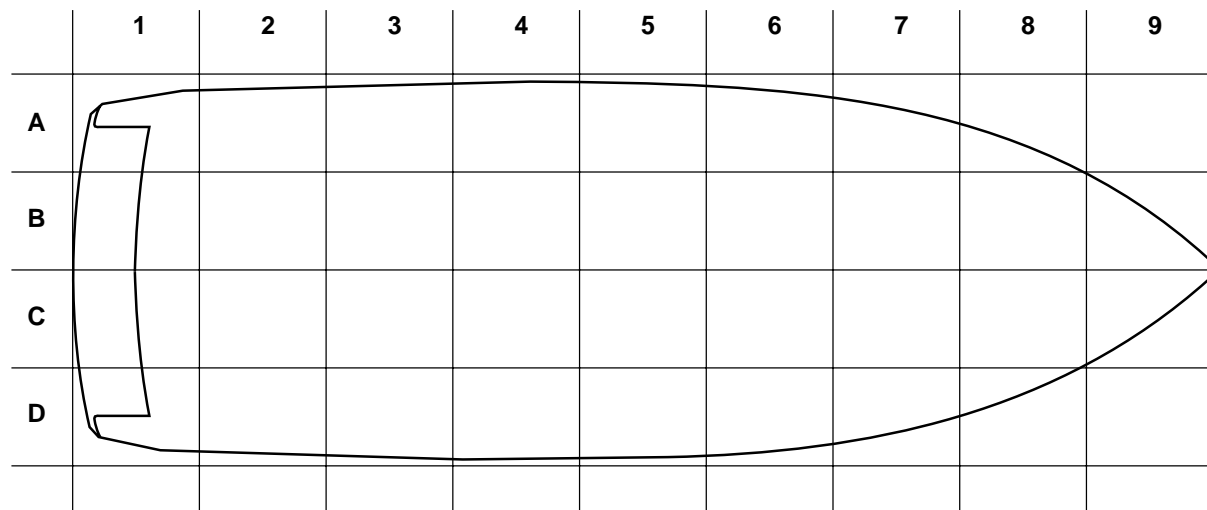

FOR167

280 BR Equipment Location

Item	Location	Remarks
AC Control Panel*	D-6	STBD storage below helm
Air Conditioning Control	N/A	
Automatic Fire Extinguisher	B-2	FWD of PORT motor
Battery – Auxiliary Battery	A-2	PORT start battery
Battery – Port Start	A-2	Outboard of PORT motor
Battery – Starboard Start	D-2	Outboard of STBD motor
Battery Charger*	A-2	PORT hull side
Battery ON/OFF Switch	A-3	Beneath cockpit wetbar
Battery Parallel Switch	A-3	Beneath cockpit wetbar
Bilge Pump AFT	B/C-2	Centerline of bilge floor
Bilge Pump FWD	D-6	STBD storage below helm (aft access panel)
Black Water Holding Tank*	C-3/4	Above fuel tank
Carbon Monoxide Detector	A-5	Head compartment
Circuit Breaker Panel – Helm	D-5	Helm
Circuit Breaker Panel – Aft	A-3	Beneath cockpit wetbar
Circuit Breaker – Shore Power 1*	D-3	Aft cockpit – STBD seat storage
Circuit Breaker – Shore Power 2	N/A	
Circuit Breaker – Windlass	N/A	
Circuit Breaker – Auxiliary Power	A-3	Beneath cockpit wetbar
DC Control Panel	D-6	STBD storage below helm
Drive Unit Trim Pump – PORT	A-1	Outboard of PORT motor
Drive Unit Trim Pump – STBD	D-1	Outboard of STBD motor
Engine Compartment Blowers	B/C-1	Transom
Engine Compartment Hatch Handle	C-2	Aft cockpit – behind aft backrest

*Optional

SPECIFICATIONS AND LAYOUT

280 BR Equipment Location

Item	Location	Remarks
Engine Compartment Switch	D-5	Helm
Fire Extinguisher – Cabin	D-6	STBD storage below helm
Fire Extinguisher – Cockpit	A-3	Beneath cockpit wetbar
Fresh Water Fill	D-5	STBD deck
Fresh Water Dockside Hookup	N/A	
Fresh Water Level Indicator	N/A	
Fresh Water Pump	D-6	STBD storage below helm (aft access panel)
Fresh Water Tank	B-5	Walk-thru floor storage area
Fuel Tank Fill – PORT	N/A	
Fuel Tank Fill – STBD	D-2	STBD Deck
Galvanic Isolator Monitor*	D-6	STBD storage below helm
Generator	N/A	
Gray Water Holding Tank*	C-3/4	Above fuel tank (black water holding tank)
Gray Water Manifold	N/A	
Gray Water Sump Tank	C-5	Walk-thru floor storage area
Horn Air Compressor	A-4	Behind PORT side seat backrest
Hull Identification Number	D-1	AFT STBD corner below rub rail
Hydraulic Steering Fill (Helm)	N/A	
Inverter	N/A	
iPod Cradle*	D-6	STBD storage below helm
Macerator Y-Valve*	D-2	Outboard of STBD motor
Outdrive Switch (Transom)	A-1	PORT deck wall/swim platform
Seacock – Air Conditioning Intake	N/A	
Seacock – Generator Intake	N/A	
Seacock – Macerator Discharge*	C-2	FWD of motor
Seacock – Manual Head Intake*	C-2	FWD of motor
Seacock – Raw Water Engine Intake*	B/C-2	FWD of PORT/STBD motor
Shore Power Hook-Up*	D-1	STBD deck wall/swim platform
Ski Pylon	N/A	
Spotlight Control*	D-5	Helm
Stereo Amplifier*	D-6	STBD storage below helm
Stereo Auxiliary Input	D-5	Helm
Stereo CD Changer*	D-6	STBD storage below helm
Stereo Control – Transom	A-1	PORT deck wall/swim platform
Stereo Control – Helm	D-5	Helm
Stereo Receiver	D-6	STBD storage below helm
Strainer – Air Conditioning Intake	N/A	
Strainer – Generator Intake	N/A	
Strainer – Raw Water Engine Intake*	B/C-2	FWD of PORT/STBD motor
Telephone Jack	N/A	
Telephone/TV Dockside Inlet	N/A	
Transom Shower	A-1	PORT deck wall/swim platform
Trim Tab Pump	D-2	Outboard of STBD motor
TV Antenna Amplifier	N/A	
TV Antenna/Cable Switch	N/A	
Waste Deck Plate*	D-1	STBD deck wall/swim platform
Waste Tank Indicator*	A-5	Head compartment
Waste Vacuum Generator*	C-5	Walk-thru floor storage area
Water Heater	N/A	
Wiper Access	D-6	STBD storage below helm

*Optional

SUN SPORT

280 SUN SPORT

Specifications

Approximate Weight (single/twin) 8,200 Lbs. (3,719 Kg)

Capacities:

Fuel Tank	120 Gal. (454 L)
Fresh Water Tank	20 Gal. (76 L)
Holding Tank	2.6 Gal. Std./26 Gal. Opt. (9.84 L Std./98 L Opt.)
Battery Charger	50A

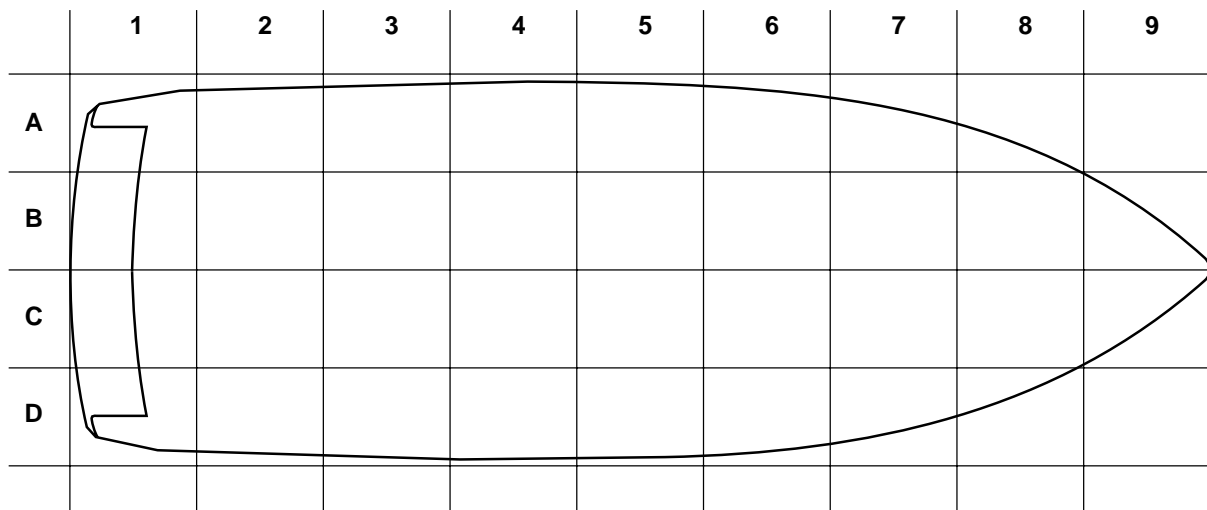

FOR167

280 SS Equipment Location

Item	Location	Remarks
AC Control Panel*	D-6	STBD storage below helm
Air Conditioning Control*	A-6	PORT galley – FWD of microwave
Automatic Fire Extinguisher	B-2	FWD of PORT motor
Battery – Auxiliary Battery	A-2	PORT start battery
Battery – Port Start	A-2	Outboard of PORT motor
Battery – Starboard Start	D-2	Outboard of STBD motor
Battery Charger*	A-2	PORT hull side
Battery ON/OFF Switch	A-3	Beneath cockpit wetbar
Battery Parallel Switch	A-3	Beneath cockpit wetbar
Bilge Pump AFT	B/C-2	Centerline of bilge floor
Bilge Pump FWD	N/A	
Black Water Holding Tank*	C-3/4	Above fuel tank
Carbon Monoxide Detector	A-6	PORT galley – FWD of microwave
Circuit Breaker Panel – Helm	D-5	Helm
Circuit Breaker Panel – Aft	A-3	Beneath cockpit wetbar
Circuit Breaker – Shore Power 1*	D-3	Aft cockpit – STBD seat storage
Circuit Breaker – Shore Power 2	N/A	
Circuit Breaker – Windlass*	A-3	Beneath cockpit wetbar
Circuit Breaker – Auxiliary Power	A-3	Beneath cockpit wetbar
DC Control Panel	A-6	PORT galley – hanging locker
Drive Unit Trim Pump – PORT	A-1	Outboard of PORT motor
Drive Unit Trim Pump – STBD	D-1	Outboard of STBD motor
Engine Compartment Blowers	B/C-1	Transom
Engine Compartment Hatch Handle	C-2	Aft cockpit – behind aft backrest

*Optional

SPECIFICATIONS AND LAYOUT

280 SS Equipment Location

Item	Location	Remarks
Engine Compartment Switch	D-5	Helm
Fire Extinguisher – Cabin	A-6	PORT galley (storage beneath counter)
Fire Extinguisher – Cockpit	A-3	Beneath cockpit wetbar
Fresh Water Fill	C-9	STBD deck
Fresh Water Dockside Hookup	N/A	
Fresh Water Level Indicator	N/A	
Fresh Water Pump	B/C-8	FWD of fore V-berth cushion
Fresh Water Tank	B/C-8	Beneath V-berth FWD cushion
Fuel Tank Fill – PORT	N/A	
Fuel Tank Fill – STBD	D-2	STBD Deck
Galvanic Isolator Monitor*	A-6	PORT galley – FWD of microwave
Generator	N/A	
Gray Water Holding Tank*	C-3/4	Above fuel tank (black water holding tank)
Gray Water Manifold	N/A	
Gray Water Sump Tank*	C-5	Aft cabin
Horn Air Compressor	A-4	Behind PORT side seat backrest
Hull Identification Number	D-1	AFT STBD corner below rub rail
Hydraulic Steering Fill (Helm)	N/A	
Inverter*	C-7	FWD head wall
iPod Cradle*	A-6	PORT galley – hanging locker
Macerator Y-Valve*	D-2	Outboard of STBD motor
Outdrive Switch (Transom)	A-1	PORT deck wall/swim platform
Seacock – Air Conditioning Intake*	B-2	FWD of PORT motor
Seacock – Generator Intake	N/A	
Seacock – Macerator Discharge*	C-2	FWD of STBD motor
Seacock – Manual Head Intake*	C-2	FWD of STBD motor
Seacock – Raw Water Engine Intake*	B/C-2	FWD of PORT/STBD motor
Shore Power Hook-Up*	D-1	STBD deck wall/swim platform
Ski Pylon	N/A	
Spotlight Control*	D-5	Helm
Stereo Amplifier*	D-6	STBD storage below helm
Stereo Auxiliary Input	D-5	Helm
Stereo CD Changer*	A-6	PORT galley – hanging locker
Stereo Control – Transom	A-1	PORT deck wall/swim platform
Stereo Control – Helm	D-5	Helm
Stereo Receiver	A-6	PORT galley
Strainer – Air Conditioning Intake*	B-2	FWD of PORT motor
Strainer – Generator Intake	N/A	
Strainer – Raw Water Engine Intake*	B/C-2	FWD of PORT/STBD motor
Telephone Jack*	D-6	FWD head wall
Telephone/TV Dockside Inlet*	D-1	STBD deck wall/swim platform
Transom Shower	A-1	PORT deck wall/swim platform
Trim Tab Pump	D-2	Outboard of STBD motor
TV Antenna Amplifier*	A-6	PORT galley (storage beneath counter)
TV Antenna/Cable Switch*	A-6	PORT galley (storage beneath counter)
Waste Deck Plate*	D-1	STBD deck wall/swim platform
Waste Tank Indicator*	D-5	Head compartment
Waste Vacuum Generator*	C-5	Aft cabin – STBD side behind coaming PNL
Water Heater	N/A	
Wiper Access	D-6	Head compartment

*Optional

SUN SPORT

310 BOWRIDER

Specifications

Approximate Weight

Capacities:

Fuel Tank	130 Gal. (492 L)
Fresh Water Tank	30 Gal. (113 L)
Holding Tank	36 Gal. (136 L)
Battery Charger	50A

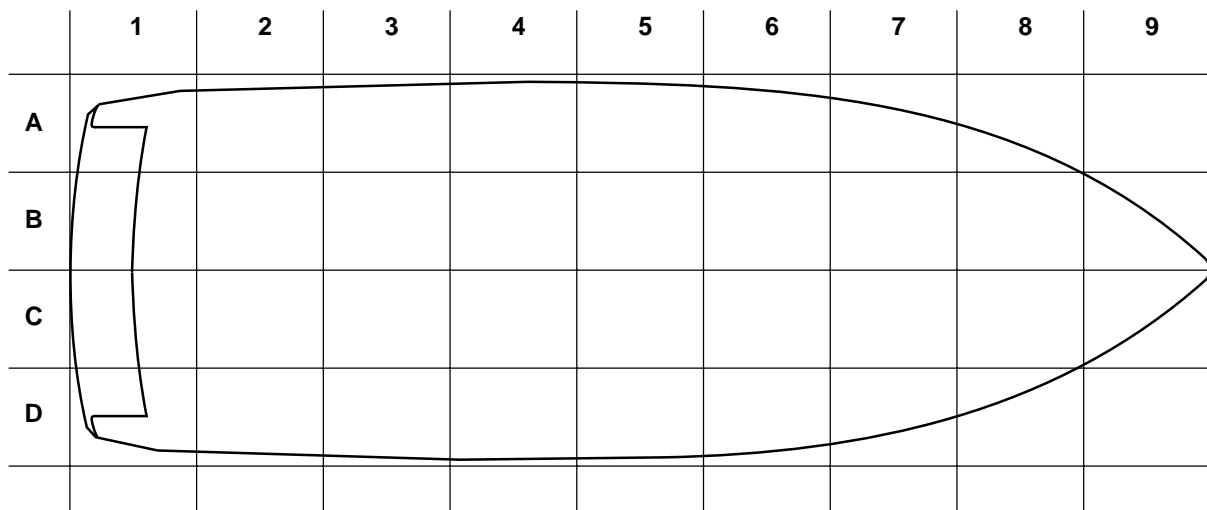

FOR167

310 BR Equipment Location

Item	Location	Remarks
AC Control Panel*	D-6	STBD helm storage area
Air Conditioning Control	N/A	
Automatic Fire Extinguisher	A-2	PORT hull side
Battery – Auxiliary Battery	A-2	PORT start battery
Battery – Port Start	A-2	Outboard of PORT motor
Battery – Starboard Start	D-2	Outboard of STBD motor
Battery Charger*	A-2	PORT hull side
Battery ON/OFF Switch	A-3	Aft storage below wetbar
Battery Parallel Switch	A-3	Aft storage below wetbar
Bilge Pump AFT	B/C-2	Centerline FWD of motors
Bilge Pump FWD	B/C-6	W/S walk-thru storage area
Black Water Holding Tank	C-3/4	Beneath cockpit floor – access via jump seat
Carbon Monoxide Detector	A-6	Head unit
Circuit Breaker Panel – Helm	D-5	Below dash
Circuit Breaker Panel – Aft	A-3	Aft storage below wetbar
Circuit Breaker – Shore Power 1	D-3	Aft cockpit – STBD seat storage
Circuit Breaker – Shore Power 2	N/A	
Circuit Breaker – Windlass*	A-3	Aft storage below wetbar
Circuit Breaker – Auxiliary Power	A-3	Aft storage below wetbar
DC Control Panel	D-6	STBD helm storage area
Drive Unit Trim Pump – PORT	A-1	Aft bilge corner – PORT
Drive Unit Trim Pump – STBD	D-1	Aft bilge corner – STBD
Engine Compartment Blowers	A-1	Aft bilge corner – PORT
Engine Compartment Hatch Handle	N/A	

*Optional

SPECIFICATIONS AND LAYOUT

310 BR Equipment Location

Item	Location	Remarks
Engine Compartment Switch	C/D-5	Helm
Fire Extinguisher – Cabin	D-6	STBD helm storage area
Fire Extinguisher – Cockpit	A-3	Aft storage below wetbar
Fresh Water Fill	D-6	Below STBD W/S wing
Fresh Water Dockside Hookup	D-1	STBD deck wall/swim platform
Fresh Water Level Indicator	N/A	
Fresh Water Pump	C-5	W/S walk-thru storage area
Fresh Water Tank	B/C-5	W/S walk-thru storage area
Fuel Tank Fill – PORT	N/A	
Fuel Tank Fill – STBD	D-2	STBD hull side
Galvanic Isolator Monitor	D-6	STBD helm storage area
Generator	N/A	
Gray Water Holding Tank	C-3/4	Black water holding tank
Gray Water Manifold	N/A	
Gray Water Sump Tank	B-5	W/S walk-thru storage area
Horn Air Compressor	A-5	PORT wall behind port side seat backrest
Hull Identification Number	D-1	AFT STBD corner below rub rail
Hydraulic Steering Fill (Helm)	N/A	
Inverter	N/A	
iPod Cradle*	D-6	STBD helm storage area
Macerator Y-Valve*	D-2	STBD hull side
Outdrive Switch (Transom)	N/A	
Seacock – Air Conditioning Intake	N/A	
Seacock – Generator Intake	N/A	
Seacock – Macerator Discharge*	D-2	Outboard of STBD motor
Seacock – Manual Head Intake	N/A	
Seacock – Raw Water Engine Intake*	B/C-2	FWD of engines
Shore Power Hook-Up*	D-1	STBD deck wall/swim platform
Ski Pylon	N/A	
Spotlight Control*	C/D-5	Helm
Stereo Amplifier	D-6	STBD helm storage area
Stereo Auxiliary Input	C/D-5	Helm
Stereo CD Changer*	D-6	STBD helm storage area
Stereo Control – Transom	D-1	STBD deck wall/swim platform
Stereo Control – Helm	C-5	Helm
Stereo Receiver	D-6	STBD helm storage area
Strainer – Air Conditioning Intake	N/A	
Strainer – Generator Intake	N/A	
Strainer – Raw Water Engine Intake*	B/C-2	FWD of engines
Telephone Jack	N/A	
Telephone/TV Dockside Inlet	N/A	
Transom Shower	A-1	PORT deck wall/swim platform
Trim Tab Pump	D-2	STBD hull side
TV Antenna Amplifier	N/A	
TV Antenna/Cable Switch	N/A	
Waste Deck Plate	D-1	STBD deck wall/swim platform
Waste Tank Indicator	A-6	Head unit
Waste Vacuum Generator	C-5	W/S walk-thru storage area
Water Heater*	A-3	FWD of PORT motor
Wiper Access	D-6	STBD helm storage area

*Optional

SUN SPORT

310 SUN SPORT

Specifications

Approximate Weight 9,750 Lbs. (4,422 Kg)

Capacities:

Fuel Tank	130 Gal. (492 L)
Fresh Water Tank	30 Gal. (113 L)
Holding Tank	36 Gal. (136 L)
Battery Charger	50A

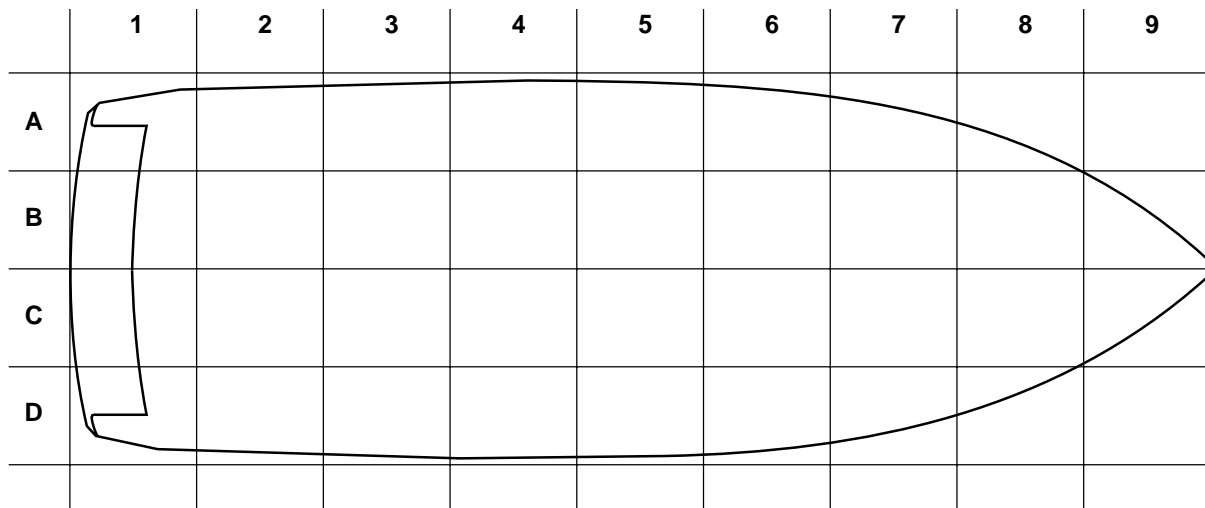

FOR167

310 SS Equipment Location

Item	Location	Remarks
AC Control Panel*	A-6	Above refrigerator
Air Conditioning Control*	D-7	FWD head wall
Automatic Fire Extinguisher	A-2	PORT hull side
Battery – Auxiliary Battery	A-2	PORT start battery
Battery – Port Start	A-2	Outboard of PORT motor
Battery – Starboard Start	D-2	Outboard of STBD motor
Battery Charger*	A-2	PORT hull side
Battery ON/OFF Switch	A-3	Aft storage below wetbar
Battery Parallel Switch	A-3	Aft storage below wetbar
Bilge Pump AFT	B/C-2	Centerline FWD of motors
Bilge Pump FWD	N/A	
Black Water Holding Tank	B/C-4	FWD of engines/on top of fuel tank
Carbon Monoxide Detector	D-7	FWD head wall
Circuit Breaker Panel – Helm	D-5	Below dash
Circuit Breaker Panel – Aft	A-3	Aft storage below wetbar
Circuit Breaker – Shore Power 1	D-3	Aft cockpit – STBD seat storage
Circuit Breaker – Shore Power 2	N/A	
Circuit Breaker – Windlass*	A-3	Aft storage below wetbar
Circuit Breaker – Auxiliary Power	A-3	Aft storage below wetbar
DC Control Panel	A-6	Above refrigerator
Drive Unit Trim Pump – PORT	A-1	Aft bilge corner – PORT
Drive Unit Trim Pump – STBD	D-1	Aft bilge corner – STBD
Engine Compartment Blowers	A-1	Aft bilge corner – PORT
Engine Compartment Hatch Handle	N/A	

*Optional

SPECIFICATIONS AND LAYOUT

310 SS Equipment Location

Item	Location	Remarks
Engine Compartment Switch	C/D-5	Helm
Fire Extinguisher – Cabin	A-6	Beneath cabin galley
Fire Extinguisher – Cockpit	A-3	Aft storage below wetbar
Fresh Water Fill	C-9	Aft of FWD STBD cleat
Fresh Water Dockside Hookup	D-1	STBD deck wall/swim platform
Fresh Water Level Indicator	N/A	
Fresh Water Pump	D-5	Aft cabin – STBD side
Fresh Water Tank	B/C-8	Beneath forward V-berth cushion
Fuel Tank Fill – PORT	N/A	
Fuel Tank Fill – STBD	D-2	STBD hull side
Galvanic Isolator Monitor*	D-7	FWD head wall
Generator*	B/C-3	Beneath cockpit floor
Gray Water Holding Tank*	B/C-4	Black water holding tank
Gray Water Manifold	N/A	
Gray Water Sump Tank	C-5	Aft cabin – STBD side
Horn Air Compressor	A-5	PORT wall behind port side seat backrest
Hull Identification Number	D-1	AFT STBD corner below rub rail
Hydraulic Steering Fill (Helm)	N/A	
Inverter*	D-7	FWD head wall
iPod Cradle*	A-6	PORT galley hanging locker
Macerator Y-Valve*	D-2	STBD hull side
Outdrive Switch (Transom)	N/A	
Seacock – Air Conditioning Intake*	C-2	FWD of STBD motor
Seacock – Generator Intake*	B-2	FWD of PORT motor
Seacock – Macerator Discharge*	D-2	Outboard of STBD motor
Seacock – Manual Head Intake	N/A	
Seacock – Raw Water Engine Intake*	B/C-2	FWD of engines
Shore Power Hook-Up*	D-1	STBD deck wall/swim platform
Ski Pylon	N/A	
Spotlight Control*	C/D-5	Helm
Stereo Amplifier*	A-6	PORT galley hanging locker
Stereo Auxiliary Input	C/D-5	Helm
Stereo CD Changer*	A-6	PORT galley hanging locker
Stereo Control – Transom	D-1	STBD deck wall/swim platform
Stereo Control – Helm	C-5	Helm
Stereo Receiver	D-7	FWD head wall
Strainer – Air Conditioning Intake*	C-2	FWD of STBD motor
Strainer – Generator Intake*	B-2	FWD of PORT motor
Strainer – Raw Water Engine Intake*	B/C-2	FWD of engines
Telephone Jack*	D-7	FWD head wall
Telephone/TV Dockside Inlet*	D-1	STBD deck wall/swim platform
Transom Shower	A-1	PORT deck wall/swim platform
Trim Tab Pump	D-2	STBD hull side
TV Antenna Amplifier*	A-6	Beneath cabin galley
TV Antenna/Cable Switch*	A-6	Beneath cabin galley
Waste Deck Plate	D-1	STBD deck wall/swim platform
Waste Tank Indicator	D-6	Head unit
Waste Vacuum Generator	C-5	Aft cabin – STBD side
Water Heater*	A-3	FWD of PORT motor
Wiper Access	D-6	Head unit

*Optional

SUN SPORT

330 SUN SPORT

Specifications

Approximate Weight 10,950 Lbs. (4,967 Kg)

Capacities:

Fuel Tank	160 Gal. (606 L)
Fresh Water Tank	20 Gal. (76 L)
Holding Tank	26 Gal. (98 L)
Battery Charger	50A

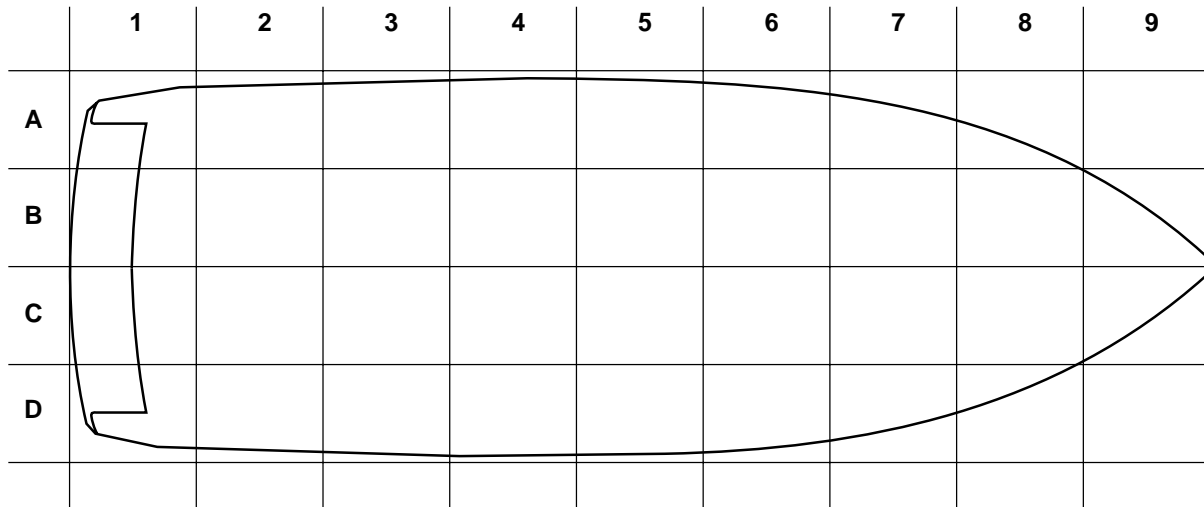

FOR167

330 SS Equipment Location

Item	Location	Remarks
AC Control Panel	A-6	PORT galley – above refrigerator
Air Conditioning Control*	D-7	FWD head wall
Automatic Fire Extinguisher	B-2	Engine compartment FWD bulkhead
Battery – Auxiliary Battery	A-2	PORT start battery
Battery – Port Start	A-2	Outboard of PORT motor (aft)
Battery – Starboard Start	A-2	Outboard of PORT motor (fore)
Battery Charger	A-2	PORT hull side
Battery ON/OFF Switch	A-3	Beneath cockpit wetbar
Battery Parallel Switch	A-3	Beneath cockpit wetbar
Bilge Pump AFT	B/C-2	Centerline of bilge floor – FWD of engines
Bilge Pump FWD	N/A	
Black Water Holding Tank*	C-3/4	Above fuel tank
Carbon Monoxide Detector	A-5	PORT galley – mirrored wall
Circuit Breaker Panel – Helm	D-5	Helm
Circuit Breaker Panel – Aft	A-3	Beneath cockpit wetbar
Circuit Breaker – Shore Power 1	D-3	Aft cockpit – STBD seat storage
Circuit Breaker – Shore Power 2	N/A	
Circuit Breaker – Windlass*	A-3	Beneath cockpit wetbar
Circuit Breaker – Auxiliary Power	A-3	Beneath cockpit wetbar
DC Control Panel	A-6	PORT galley – above refrigerator
Drive Unit Trim Pump – PORT	A-1	Outboard of PORT motor
Drive Unit Trim Pump – STBD	D-1	Outboard of STBD motor
Engine Compartment Blowers	B/C-1	Transom
Engine Compartment Hatch Handle	C-2	Aft cockpit – behind aft backrest

*Optional

SPECIFICATIONS AND LAYOUT

330 SS Equipment Location

Item	Location	Remarks
Engine Compartment Switch	D-5	Helm
Fire Extinguisher – Cabin	A-6	PORT galley (storage beneath counter)
Fire Extinguisher – Cockpit	A-3	Beneath cockpit wetbar
Fresh Water Fill	C-9	STBD cleat
Fresh Water Dockside Hookup	D-1	STBD deck wall/swim platform
Fresh Water Level Indicator	N/A	
Fresh Water Pump	B/C-8	Behind false wall FWD of V-berth FWD cushion
Fresh Water Tank	B/C-8	Beneath V-berth FWD cushion
Fuel Tank Fill – PORT	N/A	
Fuel Tank Fill – STBD	D-2	STBD Deck
Galvanic Isolator Monitor	A-6	FWD side of PORT galley
Generator*	B/C-2	FWD of motors
Gray Water Holding Tank*	C-3/4	Above fuel tank (black water holding tank)
Gray Water Manifold	N/A	
Gray Water Sump Tank	B/C-2	Centerline of bilge floor – FWD of engines
Horn Air Compressor	A-4	Behind PORT side seat backrest
Hull Identification Number	D-1	AFT STBD corner below rub rail
Hydraulic Steering Fill (Helm)	N/A	
Inverter*	D-6	FWD head wall
iPod Cradle*	A-5	PORT galley hanging locker
Macerator Y-Valve*	D-2	Outboard of STBD motor
Outdrive Switch (Transom)	N/A	
Seacock – Air Conditioning Intake*	B-2	FWD of PORT motor
Seacock – Generator Intake*	C-2	FWD of STBD motor
Seacock – Macerator Discharge*	C-2	FWD of STBD motor
Seacock – Manual Head Intake*	N/A	
Seacock – Raw Water Engine Intake*	B/C-2	FWD of PORT/STBD motor
Shore Power Hook-Up*	D-1	STBD deck wall/swim platform
Ski Pylon	N/A	
Spotlight Control*	D-5	Helm
Stereo Amplifier*	A-5	PORT galley hanging locker
Stereo Auxiliary Input	D-5	Helm
Stereo CD Changer*	A-5	PORT galley hanging locker
Stereo Control – Transom	A-1	PORT deck wall/swim platform
Stereo Control – Helm	D-5	Helm
Stereo Receiver	D-6	STBD storage below helm
Strainer – Air Conditioning Intake*	B-2	FWD of PORT motor
Strainer – Generator Intake*	C-2	FWD of STBD motor
Strainer – Raw Water Engine Intake*	B/C-2	FWD of PORT/STBD motor
Telephone Jack*	D-6	FWD of head unit
Telephone/TV Dockside Inlet*	D-1	STBD deck wall/swim platform
Transom Shower	A-1	STBD deck wall/swim platform
Trim Tab Pump	D-2	Outboard of STBD motor
TV Antenna Amplifier*	A-6	PORT galley (storage beneath counter)
TV Antenna/Cable Switch*	A-6	PORT galley (storage beneath counter)
Waste Deck Plate	D-1	STBD deck wall/swim platform
Waste Tank Indicator	D-5	Head compartment
Waste Vacuum Generator	C-5	Aft cabin
Water Heater*	D-2	FWD and outboard of STBD motor
Wiper Access	D-6	STBD storage below helm

*Optional

SUN SPORT

350 SUN SPORT

Specifications

Approximate Weight N/A

Capacities:

Fuel Tank	184 Gal. (696 L)
Fresh Water Tank	30 Gal. (113 L)
Holding Tank	36 Gal. (136 L)
Battery Charger	N/A

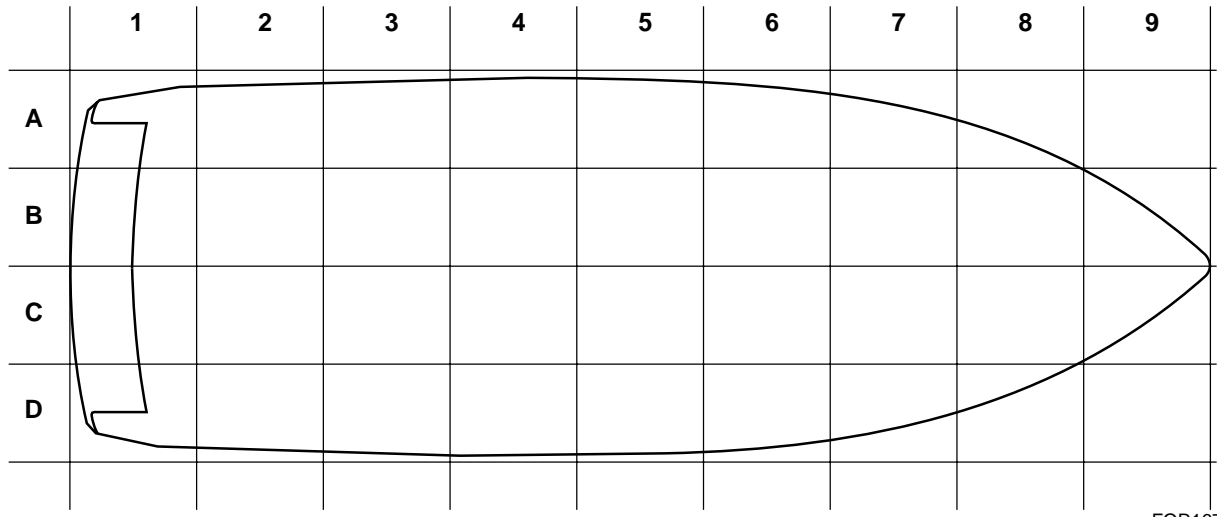

FOR167

350 SS Equipment Location

Item	Location	Remarks
AC Control Panel		
Air Conditioning Control		
Automatic Fire Extinguisher		
Battery – Auxiliary Battery		
Battery – Port Start		
Battery – Starboard Start		
Battery Charger		
Battery ON/OFF Switch		
Battery Parallel Switch		
Bilge Pump AFT		
Bilge Pump FWD		
Black Water Holding Tank		
Carbon Monoxide Detector		
Circuit Breaker Panel – Helm		
Circuit Breaker Panel – Aft		
Circuit Breaker – Shore Power 1		
Circuit Breaker – Shore Power 2		
Circuit Breaker – Windlass		
Circuit Breaker – Auxiliary Power		
DC Control Panel		
Drive Unit Trim Pump – PORT		
Drive Unit Trim Pump – STBD		
Engine Compartment Blowers		
Engine Compartment Hatch Handle		

SPECIFICATIONS AND LAYOUT

350 SS Equipment Location

Item	Location	Remarks
Engine Compartment Switch		
Fire Extinguisher – Cabin		
Fire Extinguisher – Cockpit		
Fresh Water Fill		
Fresh Water Dockside Hookup		
Fresh Water Level Indicator		
Fresh Water Pump		
Fresh Water Tank		
Fuel Tank Fill – PORT		
Fuel Tank Fill – STBD		
Galvanic Isolator Monitor		
Generator		
Gray Water Holding Tank		
Gray Water Manifold		
Gray Water Sump Tank		
Horn Air Compressor		
Hull Identification Number		
Hydraulic Steering Fill (Helm)		
Inverter		
iPod Cradle		
Macerator Y-Valve		
Outdrive Switch (Transom)		
Seacock – Air Conditioning Intake		
Seacock – Generator Intake		
Seacock – Macerator Discharge		
Seacock – Manual Head Intake		
Seacock – Raw Water Engine Intake		
Shore Power Hook-Up		
Ski Pylon		
Spotlight Control		
Stereo Amplifier		
Stereo Auxiliary Input		
Stereo CD Changer		
Stereo Control – Transom		
Stereo Control – Helm		
Stereo Receiver		
Strainer – Air Conditioning Intake		
Strainer – Generator Intake		
Strainer – Raw Water Engine Intake		
Telephone Jack		
Telephone/TV Dockside Inlet		
Transom Shower		
Trim Tab Pump		
TV Antenna Amplifier		
TV Antenna/Cable Switch		
Waste Deck Plate		
Waste Tank Indicator		
Waste Vacuum Generator		
Water Heater		
Wiper Access		

SUN SPORT



Section 4 Controls and Indicators

Knowing the controls and indicators on your boat is essential for safe and proper operation.

GAUGES

Each engine has its own set of gauges. On dual engine boats, the port set of gauges is for monitoring operation of the port engine. The starboard set is for monitoring operation of the starboard engine. The gauges are illuminated for night operation.

On occasion, a small fluctuation in a gauge reading is not unusual. If an instrument reading is outside the normal or recommended ranges, determine the cause or see your Formula dealer. Refer to the propulsion unit operator's manual for normal recommended ranges.

Tachometer—Registers engine speed in revolutions per minute (RPM). Use this gauge to keep the engine within the proper operating range.

An hour meter is incorporated in the tachometer. The hour meter accumulates engine operating time, and is activated when the ignition switch is ON. Consult your propulsion unit operator's manual for the proper RPM operating range for your engines.

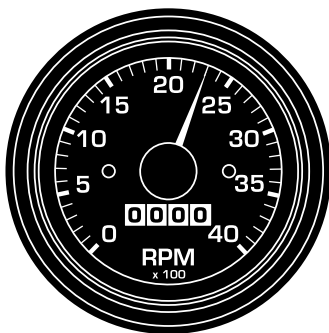

FOR071

Tachometer
Figure 4-1

Speedometer—Registers forward speed in miles per hour. Use this gauge to monitor fuel consumption and propeller performance. Since its input is received from a water pressure hose, accuracy is only approximate.

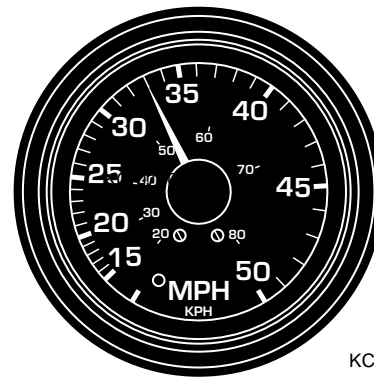

KC-0710

Speedometer
Figure 4-2

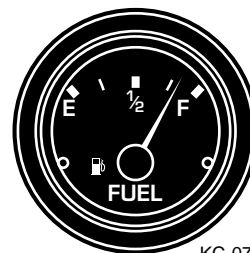

KC-0720

Fuel Level Gauge
Figure 4-3

Fuel Level Gauge—Measures approximate level of fuel in a fuel tank. The ignition switch must be in the RUN position to activate the gauge. Since the accuracy of your gauge varies with the attitude of your Formula boat (trim and list), and the fuel pick-up tube

cannot withdraw all fuel out of the tank, please observe the One Third Rule. Use one third of your fuel to go out, one third to come back and one third as a reserve.

SUN SPORT

Engine Water Temperature Gauge

Indicates the water/coolant temperature inside the engine. Refer to the propulsion unit operator's manual for normal operating temperature. After starting the engine, check your temperature gauge for abnormally high readings. If the reading is outside the manufacturer's operating range, immediately turn off the engine. An abnormally high temperature is the result of cooling water blockage. Consult your Formula dealer when experiencing a high engine temperature reading.

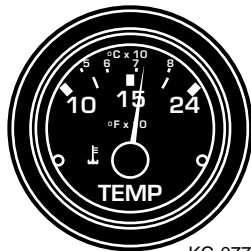

KC-0770

Engine Water Temperature Gauge
Figure 4-4

Voltmeter

Indicates the condition of the engine's cranking battery in volts DC. With the ignition switch on and the engine not running, a reading between 11.5 and 12.5 volts indicates a fully charged battery. With the engine running at idle, the gauge should read between 10 and 12 volts. With the engine running at cruising speeds and above, it should show 12 to 14 volts. Have your Formula dealer check the charging system if the voltmeter reads below these normal ranges.

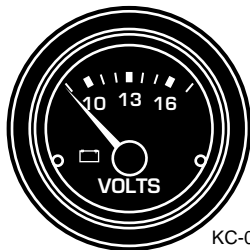

KC-0750

Voltmeter
Figure 4-5

Engine Oil Pressure Gauge

Measures the pressure of the engine's lubricating oil. Refer to the propulsion unit operator's manual for normal operating pressure. Many serious engine problems are reflected on oil pressure gauge readings. If the pressure is lower than the manufacturer's specification, immediately shut off the engine. Contact your Formula dealer to correct the problem before operating the engine.



KC-0780

Engine Oil Pressure Gauge
Figure 4-6

Trim Gauge—Displays the position of the drive unit.

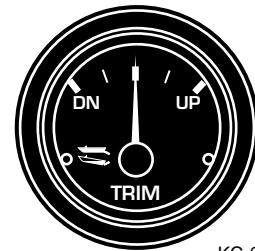

KC-0740

Trim Gauge
Figure 4-7

Depth Gauge—Displays the depth of the water under the boat. To avoid running aground in shallow water, add distance to the meter reading and maintain a very slow speed. A switch at the helm activates the gauge. For operating instructions, refer to the depth gauge instructions in your Owner Information Binder.

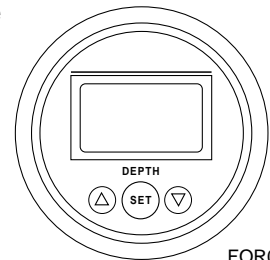

FOR055

Depth Gauge
Figure 4-8

Windlass Chain Counter—Displays the length of deployed anchor rode.

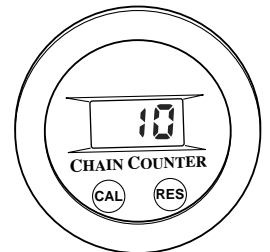

FOR305

Windlass Chain Counter
Figure 4-9

Trim Tab Indicator—Displays the deflection percentage of each trim tab.

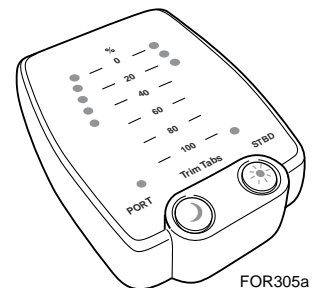

FOR305a

Trim Tab Indicator
Figure 4-10

CONTROLS AND INDICATORS

SWITCHES

Rocker-type switches are used in your Formula boat to activate an electrical circuit. Push the bottom of the switch to activate the circuit. The switch will remain ON and a light will illuminate the switch. Push the top of the switch to turn it OFF.

NOTICE

Some accessory switches (engine hatch, horn) are MOMENTARY switches. These switches must be held in place to operate the accessory. The switch returns to the OFF position when it is released.

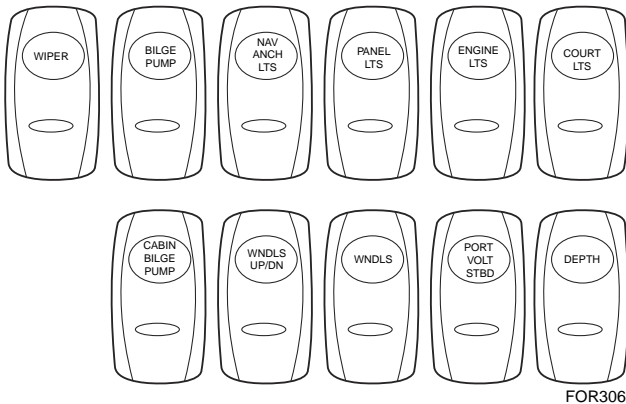

Typical Rocker-Style Switches

Figure 4-11

Blower Switch—Activates the engine compartment ventilation blower to remove explosive fumes from the area.

The blower must be operated for a minimum of four minutes before starting the engines or generator. In addition, the blower should be operated continuously when at idle or running at slow speeds.

⚠ WARNING

Failure to operate the blower can lead to conditions favorable for an explosion which can cause severe personal injury or death.

Bilge Pump Switch—Manually controls the operation of the bilge pump.

Navigational Light Switch—This three position switch activates the navigational (running) lights and the anchor light. Push the top of the switch to activate the navigational lights and all-around white anchor light. The center position is OFF. Push the bottom of the switch to activate only the anchoring light.

NOTICE

Operate the boat between sunset and sunrise using your navigational lights. Navigational lights are legally required to indicate direction and right-of-way at night.

Cockpit Courtesy Light Switch—Operates both the courtesy lighting and the bilge compartment lighting. Boats with the optional radar arch will have a 3-position switch.

Top Circuit—Push the top portion of the switch to activate all interior, bilge, swim platform and arch lighting.

Bottom Circuit—Push the bottom portion of the switch to activate only the interior, bilge and swim platform lighting.

Remote Courtesy Lights—Using the remote switching mechanism, platform, interior and bilge lighting can be operated from a distance of 300'.

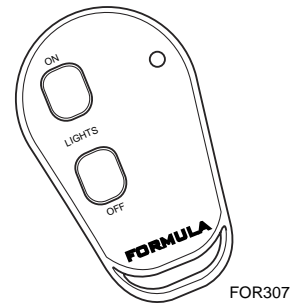

Typical Rocker-Style Switches

Figure 4-12

NOTICE

This remote lighting system is operational even with the auxiliary battery switch turned OFF. With the battery switch OFF and the remote switching mechanism activated, the lights will remain ON for 14 minutes, flash once and then remain ON for one additional minute. After 15 total minutes, the lights will turn OFF. This feature prevents the lights from draining the auxiliary battery.

Panel Light Switch—Illuminates the instrument panel when in the ON position.

Docking Lights Switch—Operates the docking lights. Docking lights are to be used for docking only. It is illegal to use your docking lights while cruising.

CAUTION

Docking lights are intended for short term use only. Use of lights for extended periods may damage the hull and/or the lights.

Wiper Switch—Activates the windshield wiper.

Horn—Depending on model, a rocker-type switch or a push-button switch is used to activate the horn.

- Press the bottom of a rocker-type switch to activate the horn.
- Press the center on a push-button switch to activate the horn.

SUN SPORT

Engine Hatch Switch—Activates the engine compartment hatch electronic lift system. The hatch lift switch is located at the helm.

The transom door must be open on Sun Sport and Bowrider models to activate the engine hatch switch.

If the battery is low or disconnected, the engine compartment hatch can be opened manually. To open, lift the leading edge of the aft seat six to eight inches and remove the fast pin connecting the hatch to the lifting ram.

Windlass Up/Down Switch—Raises and lowers the windlass. The safety pin must be removed from the lock bracket before operating the windlass. Install the safety pin when the system is not in use. For additional Windlass system information, refer to **Anchoring and Sea Anchors**, in **Section 7**.

⚠ WARNING

The safety pin must be installed in the lock bracket when the windlass is not in use. Do not operate your Formula boat without the safety pin installed.

Windlass Up/Down Switches—Windlass operation is controlled by a 3-position switch located on the dash. Power is supplied to the dash switch via the windlass breaker located on the dash circuit breaker panel.

Exhaust Diverter Switch—Controls the exhaust direction on the exhaust diverter system, if equipped.

Accessory Switch—This switch is available to operate an accessory item.

Ignition Switches—Each engine has a separate ignition switch. On dual engine boats, the left switch is for the port engine, and the right switch is for the starboard engine.

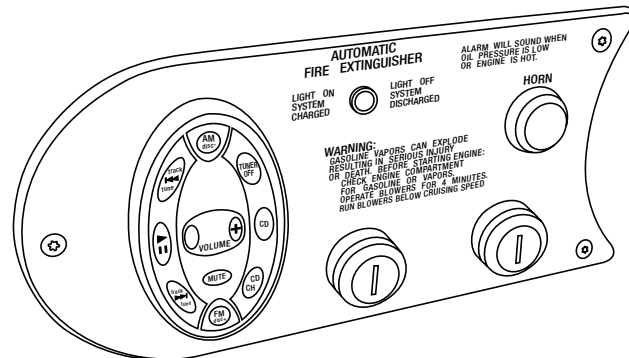

FOR256a

Ignition Switches
Figure 4-13

Ignition Safety Switches—Your Formula boat is equipped an ignition safety switch for each engine.

CAUTION

Do not allow your Formula boat to be operated without the proper use of the ignition safety switch and lanyard.

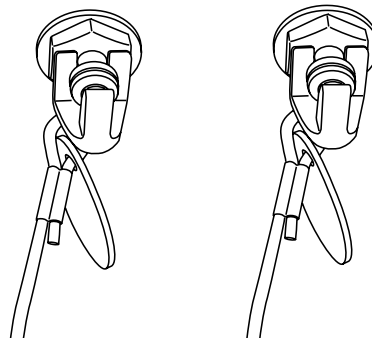

FOR057

Ignition Safety Switches
Figure 4-14

CONTROLS AND INDICATORS

The ignition safety switch and lanyard will stop an engine in case of an emergency. Attach the lanyards to the boat operator whenever the engines are running. Be aware there will be a loss of boat control if the switches are activated. If the operator is thrown from the seat or moves too far from the helm, the lanyards will become disconnected from the ignition safety switches, shutting off the engines.

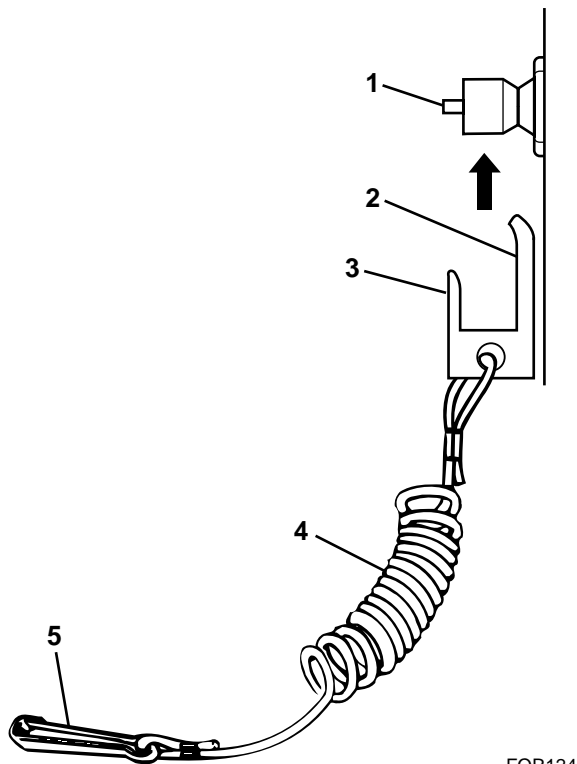

1. Ignition Safety Switch Button
2. Fork
3. Center Prong covers Safety Switch Button
4. Lanyard
5. Clothing Hook

Installing Lanyard to Ignition Safety Switch Figure 4-15

To attach a lanyard, connect the clip to the ignition safety switch and the hook to a strong piece of clothing on the operator, such as a belt loop.

⚠ WARNING

Attach the ignition safety switches' lanyards to the operator before starting the engines. This will prevent the boat from becoming a runaway if the operator is accidentally thrown away from the helm.

⚠ WARNING

The ignition safety switches can only be effective when they are in good working condition. Observe the following:

- Do not remove or modify an ignition safety switch and/or its lanyard.
- The lanyard must be free from obstructions that could interfere with its operation.

Twin Engine Trim Switch—Activates the drive unit's power trim feature. On dual engine boats, the port switch controls the port drive unit's power trim. The starboard switch controls the starboard drive unit's power trim. Push and hold the top of the switch to raise the drive unit. Push and hold the bottom of the switch to lower the drive unit. Use this switch in combination with the trim gauge to maximize your boat's performance.

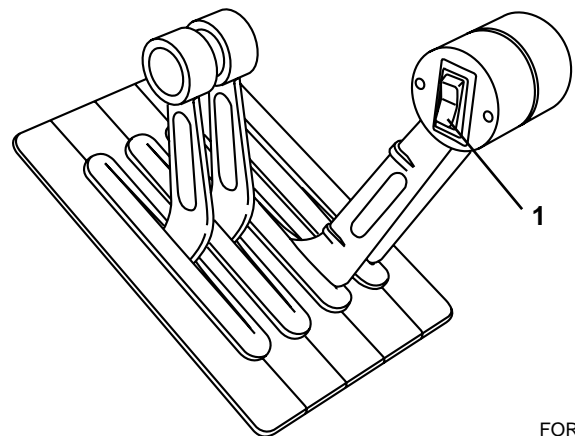

1. Trim Switch

Twin Engine Remote Control Trim Switch Figure 4-16

Dual engine remote controls have a combination port and starboard drive unit trim switch located in the throttle handle of the remote control (**Figure 4-16**). Push and hold the switch until both drive units are at the desired angle.

Twin Engine Trailer (Tilt) Switch—On some Sun Sport models, the drive units' trailer or "tilt" feature is controlled by dash-mounted rocker switches labeled "TRAILER" (**Figure 4-17**). The port switch activates the port drive unit's power tilt. The starboard switch activates the starboard drive unit's power tilt. Push the top of the switch to raise the drive unit.

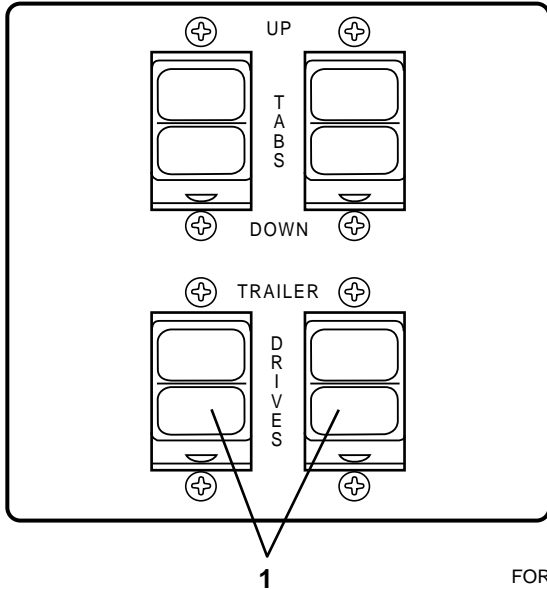

FOR133

1. Trailer Switches

**Typical Twin Engine Trailer Switches
Figure 4-17**

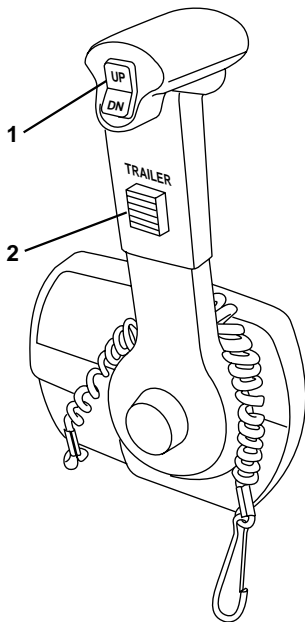

FOR220

1. Trim Switch
2. Trailer (Tilt) Switch

**Single Engine Remote Control Trim Switch
Figure 4-18**

Single Lever Trim and Trailer Switches—On a single engine remote control, the trim switch is located in the top of the control handle and the trailer (tilt) switch is in the lever arm (**Figure 4-18**). Push and hold the top or bottom of the trim switch to raise or lower the drive unit. Use this switch in combination with the trim gauge to maximize your boat performance. Push and hold the trailer switch to raise the drive for mooring or trailering.

Refer to **Trimming-Drive Units and Trim Tabs**, in **Section 7**, for additional information.

Trim Tab Switch—Labeled "TABS," these switches control the operation of the trim tabs. Adjusting trim tabs will improve the ride of your boat and correct listing from side to side due to varying weight distribution and/or sea and wind conditions. Refer to **Trimming-Drive Units and Trim Tabs**, in **Section 7**, for further trimming procedures.

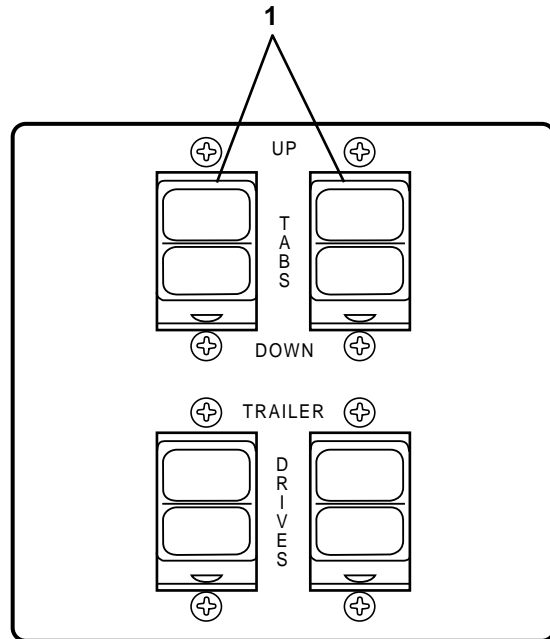

FOR132

1. Trim Tab Switches

**Typical Trim Tab Switches
Figure 4-19**

CONTROLS AND INDICATORS

CIRCUIT BREAKERS

A circuit breaker panel(s) is located at the helm. Most electrical equipment is controlled with circuit breakers. These breakers will activate if overloaded and cut power to the switch. To restore power, push the button in and release. If a circuit continuously overloads under normal operating conditions, have your boat inspected by your Formula dealer immediately.

Your Formula has additional circuit breaker panels. For the location of these panels, refer to **Specifications**, in **Section 3**, for your specific model.

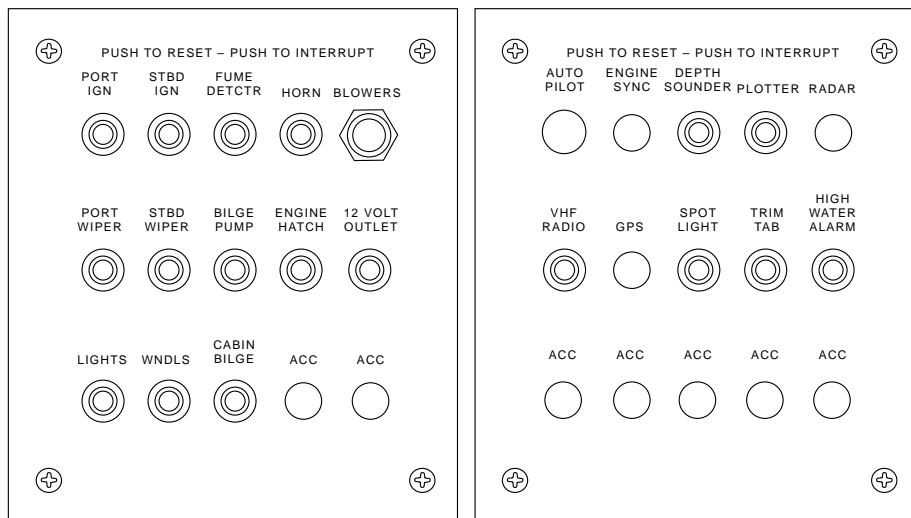

FOR011

Typical Circuit Breaker Panel
Figure 4-20

SUN SPORT

STEERING

Your Formula boat is equipped with a tilt steering wheel. Adjust the tilt position by grasping the top of the steering wheel and depressing the release lever with your thumb. Release the lever to lock the steering wheel when achieving a comfortable position.

⚠ WARNING

Do not adjust the steering wheel tilt position while the boat is moving. Sudden boat movement may cause loss of balance resulting in loss of control and/or injury.

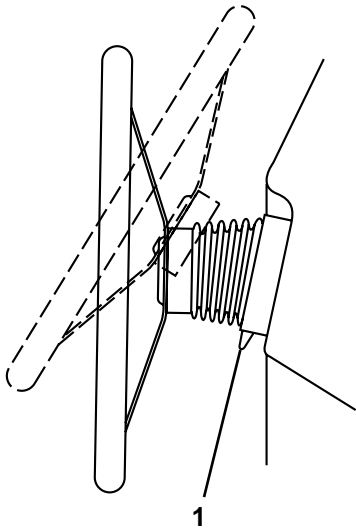

FOR059

1. Release Lever

**Tilt Steering Wheel
Figure 4-21**

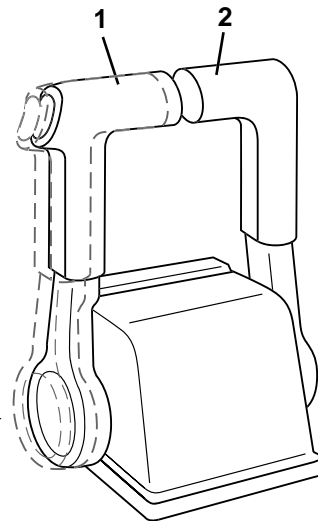
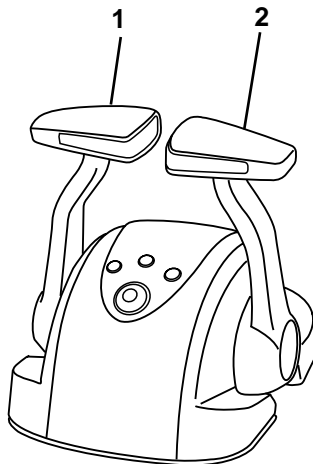
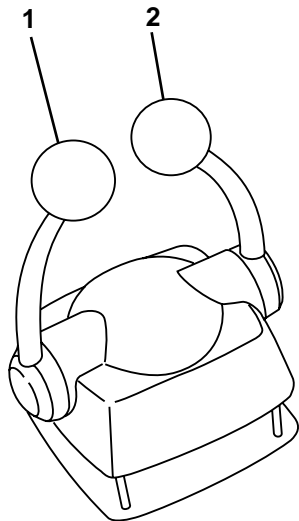

FOR224

1. Port Control Lever
2. Starboard Control Lever

**Typical Twin Engine - Single Lever Controls
Figure 4-22**

REMOTE CONTROLS

NOTICE

Your Formula boat is equipped with a safety switch for “start-in-neutral-only” operation. Be sure the shift lever is in NEUTRAL before attempting to start an engine.

The shift/throttle control on your Formula boat differs from model to model and may depend on the engine used. The following information relates to the general description about remote controls. Refer to the propulsion unit operator's manual or the control operator's manual for specific use.

The shift lever controls the drive unit. The throttle lever controls the engine speed. One of two different types of controls may be used: a single lever which combines both shift and throttle functions for each engine/drive, or a dual lever with one lever controlling the shift function and the other lever controlling the throttle function of each engine/drive.

Single Lever Controls

Single lever shift/throttle controls are grouped together for easier one-hand operation. When the lever(s) is “centered” in the detent position, the transmission is in NEUTRAL. Pushing the lever(s) forward engages the forward gear – continue pushing to increase engine speed. Pulling the lever(s) back engages the reverse gear – continue pulling to increase engine speed.

Twin Engines—With single lever controls for twin engines (**Figure 4-22**), the lever(s) is usually moved away from the base for “throttle advance only” operation during starting and warmup.

CONTROLS AND INDICATORS

Single Engines—With single lever controls for single engines (**Figure 4-23**), you must first push the release button for “throttle advance only” operation during starting and warmup.

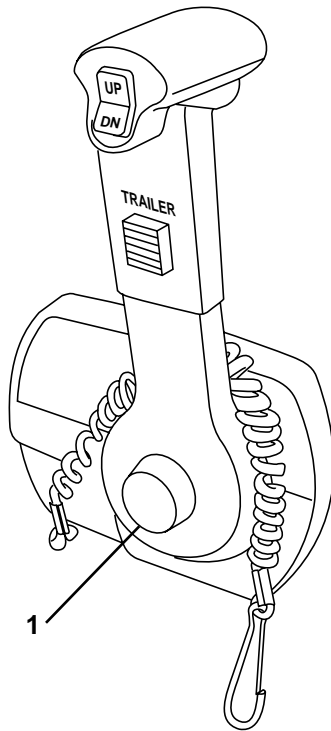

1. Release Button

Single Engine Remote Control
Figure 4-23

FOR220A

Dual Lever Controls

Dual lever controls have separate shift and throttle levers for each engine (**Figure 4-24**).

The left levers are for the port engine and the right levers are for the starboard engine. The controls are arranged with the shift levers (all one size and color) grouped together and throttle levers (all the same size and color, and larger than the shift levers) grouped together.

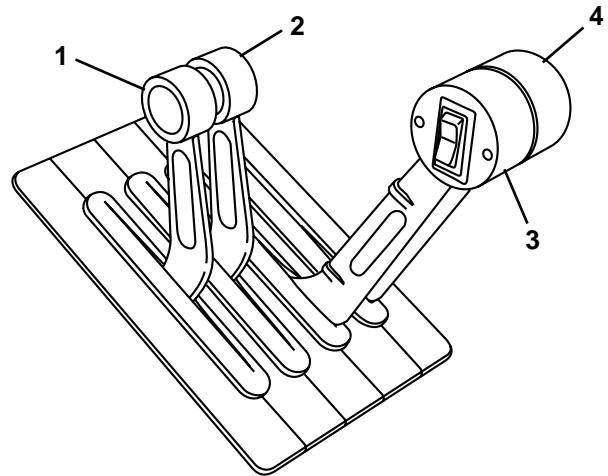

1. Port Engine Shift Lever
2. Starboard Engine Shift Lever
3. Port Engine Throttle Lever
4. Starboard Engine Throttle Lever

Typical Dual Lever Remote Control
Figure 4-24

FOR097

SUN SPORT

HELM CONTROLS AND INDICATORS

Compass—Aids in navigation of your Formula boat, a compass is mounted at the helm. Refer to the compass user's manual supplied in your Owner Information Binder for operating information.

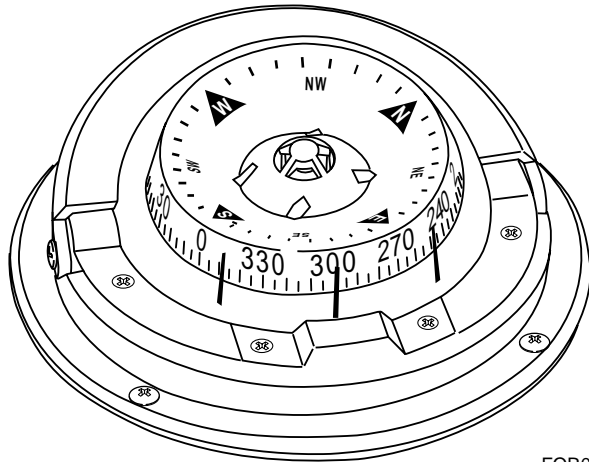

FOR025

Compass
Figure 4-25

Stereo Remote Control—This provides full-feature stereo remote control from the helm and/or transom (Figure 4-26).

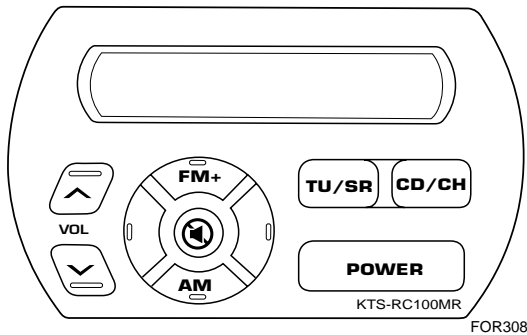

FOR308

Stereo Remote Control
Figure 4-26

Stereo Remote Volume Control—Controls local volume of the stereo (generally, cockpit). Depending on the particular Sun Sport model, a remote volume control may or may not be installed (Figure 4-27).

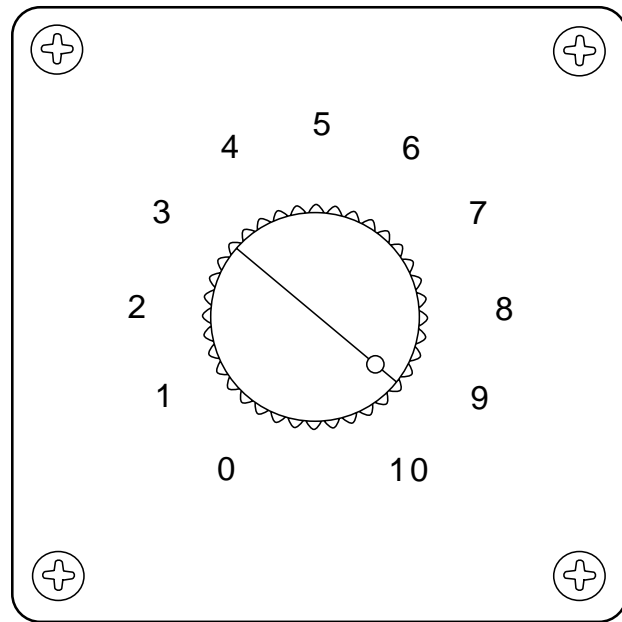

FOR013

Stereo Remote Volume Control
Figure 4-27

Automatic Fire Extinguisher Indicator—Monitors the fixed automatic fire extinguisher mounted in the engine compartment. The automatic fire extinguisher indicator light is located at the helm. When the light is on, the system is charged. When the light is off, the system is discharged and needs attention. Refer to **Automatic Fire Extinguisher**, in **Section 5**, for additional information.

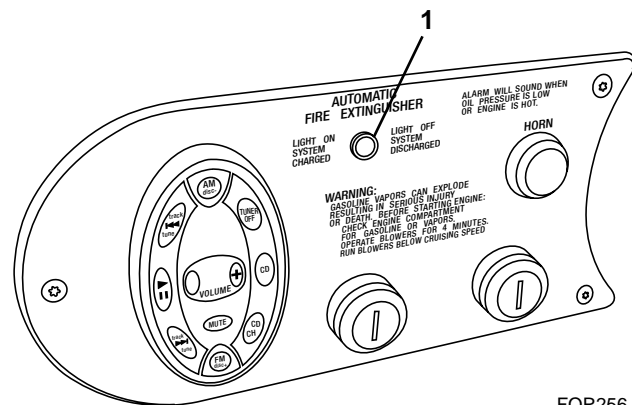

FOR256

1. Indicator Light

Automatic Fire Extinguisher Indicator Light
Figure 4-28

CONTROLS AND INDICATORS

Fume Detector Gauge—Monitors the engine compartment for excessive fuel fumes. The gauge is mounted at the helm and a sensor is located in the bilge area where fumes collect. The system also monitors for unburned hydrocarbons from a faulty exhaust system and hydrogen battery vapors. Refer to the fume detector owner's manual for additional information.

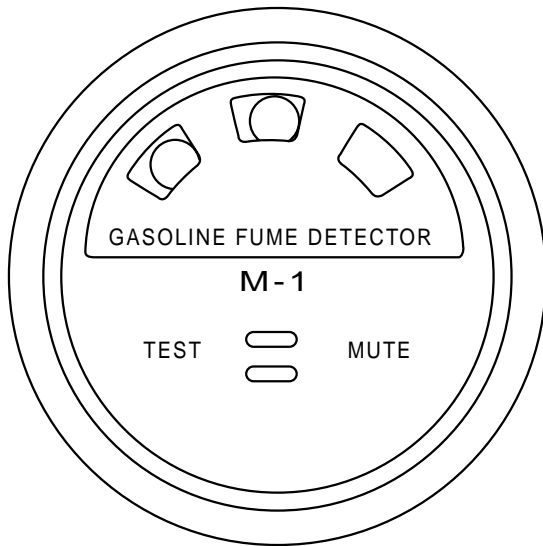

FOR012

Fume Detector Gauge
Figure 4-29

⚠ WARNING

The fume detector system should be considered a supplemental warning system. It is not meant to replace standard safety practices which should be followed around explosive gases.

If the fume detector indicates a dangerous condition, do the following:

- Do not operate electrical equipment.
- Extinguish open flames and smoking materials immediately.
- Turn OFF the engines and generator.
- Wait five minutes before opening the engine compartment to investigate the cause.
- Determine the cause and correct it immediately before resuming operation.

Bilge High Water Alarm—Alerts operator of excessive water in the bilge. Sounding of the alarm may be an indication of a) problems with the automatic bilge pump system, or b) an intrusion of water which exceeds the bilge pump system's removal capabilities. A sensor mounted in the engine compartment activates the alarm, which manifests itself as a shrill wavering siren. The alarm has a built-in 10-second delay, which is designed to eliminate nuisance tripping (i.e., the alarm will not sound unless the sensor is activated continuously for 10 seconds or greater). The alarm will stop once the excessive water is cleared. Refer to **Bilge and Blower System in Section 5**.

Engine Alarm—Sounds an alarm when an engine temperature exceeds the set limit or if the oil pressure drops below the set range. If the alarm sounds during operation, immediately turn OFF the engine and determine the cause. The engine alarm will also sound if the outdrive lube level falls to a critical level. Consult the propulsion unit owner's manual in your Owner Information Binder for additional information.

CAUTION

Continued operation of an engine after the warning alarm has sounded may cause severe engine damage.

CABIN CONTROLS AND INDICATORS

AC/DC Control Panel—This panel controls the distribution of the 110-volt alternating current (VAC) electrical system and the 12-volt direct current (VDC) electrical system.

Both the AC and DC circuits are controlled by switch-type circuit breakers. The circuit breakers serve two functions: 1) They allow you to manually enable or disable a circuit by moving the switch ON or OFF, and 2) they protect the system by automatically opening the circuit if a short or overloaded condition occurs.

Check the circuit if a particular piece of equipment stops working. A tripped circuit breaker indicates the circuit is overloaded. You should determine and correct the cause of a problem before resetting a circuit breaker.

Reset the breaker by pressing it back into place. Contact your Formula dealer if a circuit breaker trips repeatedly.

Refer to **Section 5** for operation of the 12-VDC and 110-VAC electrical systems.

SUN SPORT

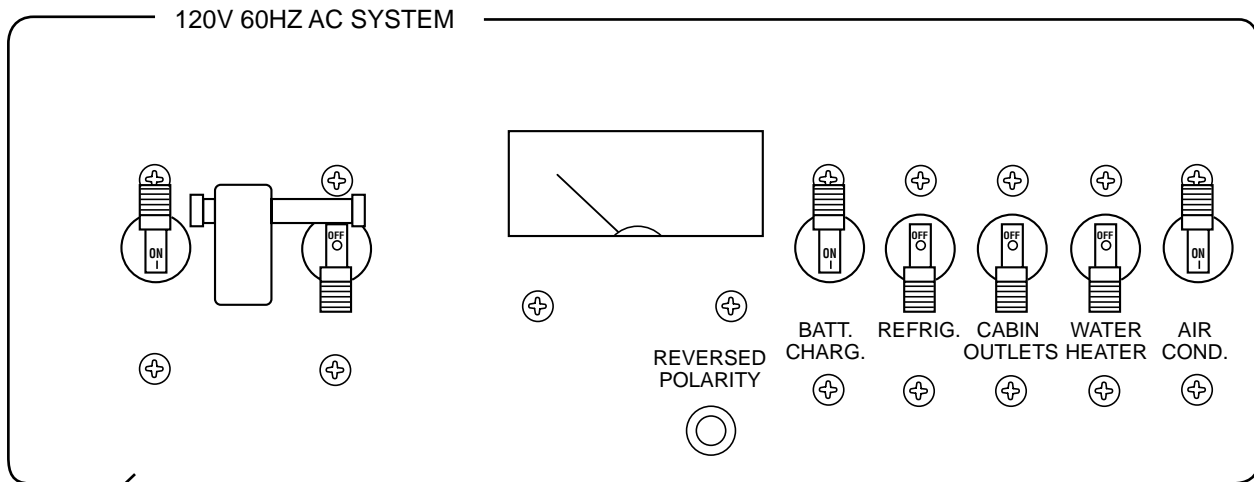

1

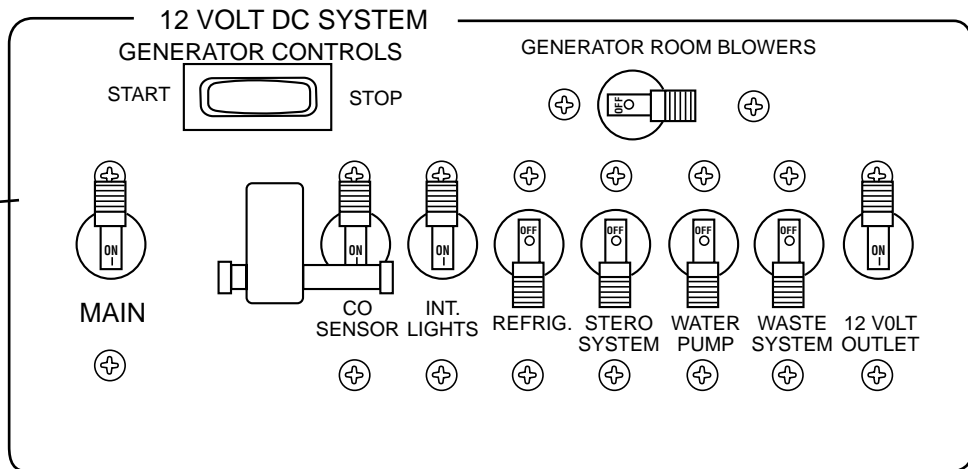

2

FOR137

1. AC Control Panel
2. DC Control Panel

AC/DC Control Panel
Figure 4-30

CONTROLS AND INDICATORS

Generator Control Panel—Controls operation of the generator. The generator control panel is located on the AC/DC control panel. Refer to **Generator**, in **Section 5**, for operating information.

⚠ WARNING
Operate the generator blower for at least four minutes each time before you start the generator.

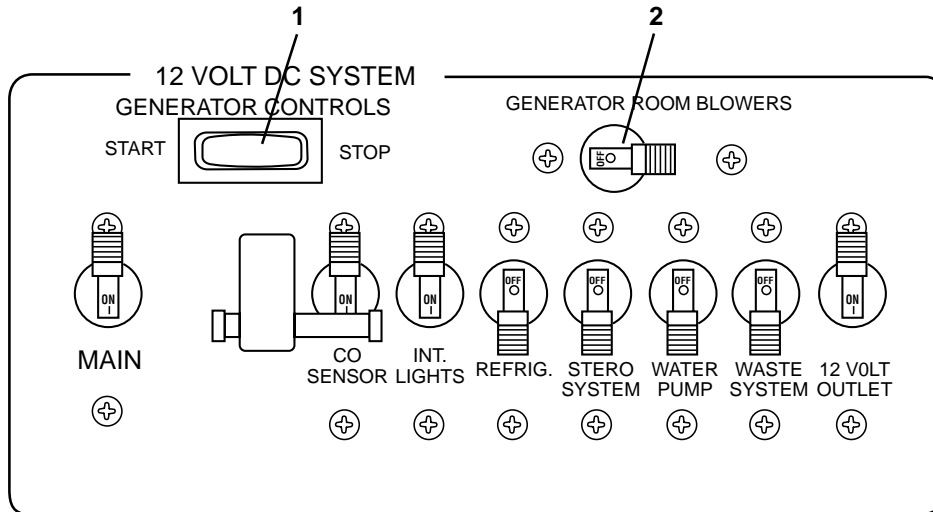

FOR138

1. Start/Stop Switch
2. Blower Switch

Generator Control Panel
Figure 4-31

Carbon Monoxide Detector—Detects carbon monoxide gas. Formula installs carbon monoxide detectors in closed-cabin models only.

⚠ DANGER
Carbon monoxide gas (CO) is colorless, odorless and extremely dangerous. All engines and fuel burning appliances produce CO as exhaust. Direct and prolonged exposure to CO will cause **BRAIN DAMAGE** or **DEATH**. Signs of exposure to CO include nausea, dizziness and drowsiness.

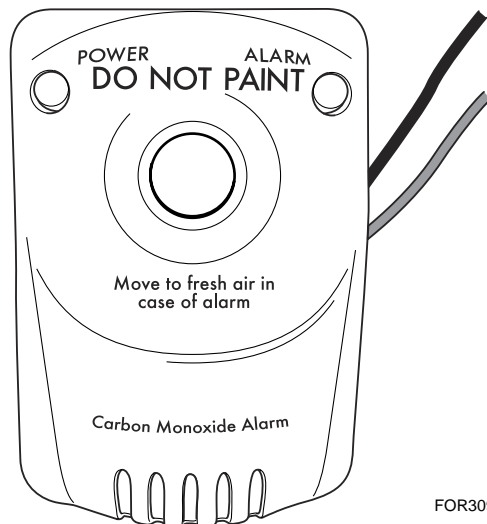

FOR309

Carbon Monoxide Detector
Figure 4-32

SUN SPORT

⚠ WARNING

Test the carbon monoxide detectors operation before each trip, at least once a week and after the boat has been in storage. Do not tamper with the operation of the carbon monoxide detectors. They are installed for your safety.

CAUTION

A carbon monoxide (CO) detector will only detect the presence of carbon monoxide gas at its sensor. Carbon monoxide may be present in other areas.

NOTICE

A carbon monoxide detector will not detect other vapors such as gasoline.

Air Conditioning Controller (optional)—Displays information and controls certain aspects relative to the associated air conditioning system. A controller (**Figure 4-33**) for each unit is located centrally, relative to the area being cooled/heated. Refer to the air conditioning owner's manual in your Owner Information Binder for operating instructions.

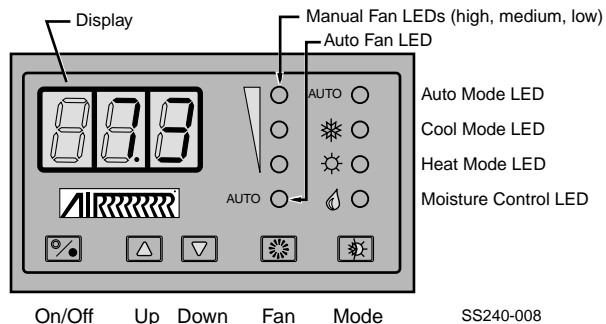

Air Conditioning Controller
Figure 4-33

Waste Tank Level Indicator—Displays the level of waste water in the tank. The indicator is located in the head. Refer to **Waste Water System**, in **Section 5**, for additional information.

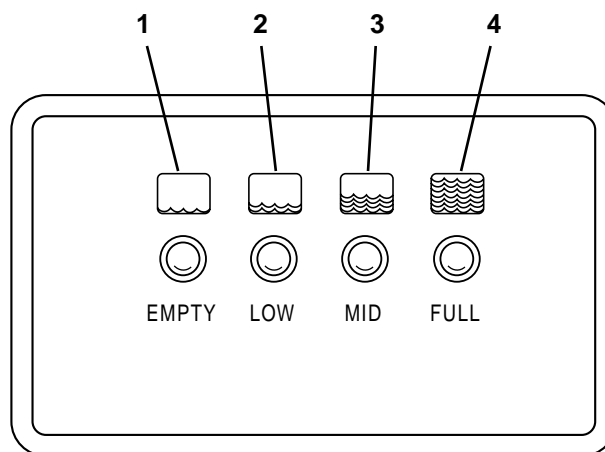

FOR018

1. Green Light—Empty
2. Yellow Light—Low
3. Orange Light—Mid
4. Red Light—Full

Waste Tank Level Indicator
Figure 4-34

VacuFlush®—Flushing is controlled by pushing down on the pedal at the base of the toilet. Lifting up on the pedal will raise the water level in the bowl, if needed. **NOTE:** Once the waste holding tank is “FULL,” the head pump is automatically disabled to prevent further flushing of the toilet until the tank has been evacuated.

Please refer to the head unit's operator manual located in your Owner's Information Binder for additional information.

CONTROLS AND INDICATORS

Macerator Control—Controls operation of the macerator waste system. Your Formula boat may be equipped with a macerator system that allows the discharging of waste water directly overboard through a seacock. The macerator control is located in the head compartment. The macerator overboard Y-valve must be opened to allow activation of the macerator pump switch. For additional operating information, refer to the macerator operator's manual.

CAUTION

Overboard discharge of waste water should only be used in approved areas. It is your responsibility to comply with local regulations regarding the discharge of waste. You could be fined if your boat has an operable overboard discharge system in a non-approved area. Removing the handle of the seacock while in a closed position, or disabling the system by other means may be required to avoid a fine.

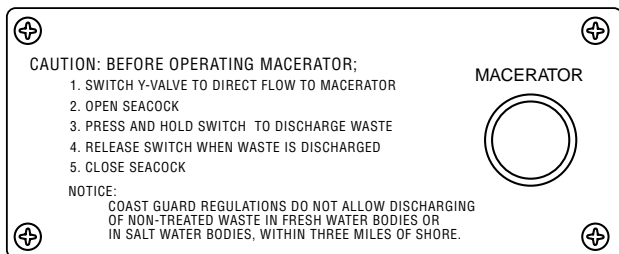

FOR222

Macerator Control Panel
Figure 4-35

BATTERY SELECTOR SWITCHES

Your Formula boat is equipped with a battery switch for each engine. The switch provides isolation and positive disconnect of the battery to protect against tampering, electrical fire hazards and draining the battery's power. The battery switch used in each Formula boat is dependent upon model and engine options.

Typical Single Engine Battery Switch—This battery switch (Figure 4-36) connects one or two batteries to the electrical circuit of an engine.

Rotate the switch to:

- No. 1 position – Power supplied to engine and 12 VDC system from battery 1 (engine alternator recharges battery 1).
- No. 2 position – Power supplied to engine and 12 VDC system from battery 2 (engine alternator recharges battery 2).
- ALL position – Power supplied to engine and 12 VDC system from batteries 1 and 2 (engine alternator recharges batteries 1 and 2).
- OFF position – Neither the engine or 12 VDC system is supplied with power.

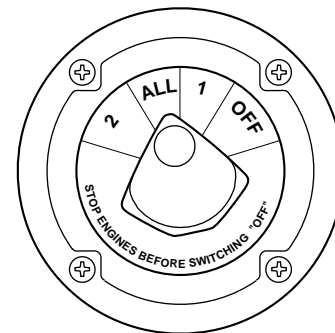

Typical Battery Selector Switch
Figure 4-36

Note: Power is supplied to the bilge pumps, high water alarm, stereo memory, and galvanic protection system through the constant power circuit, independent of the battery switch position (i.e., these components receive power even with the battery switch in the OFF position).

Formula recommends starting your engine with the battery switch in the ALL position. This will supply your engine with the most cranking power as well as charge both batteries while the engine is running. If you intend to use 12 VDC accessory power for an extended period of time without the engine running, switch to only one battery.

For the location of the battery selector switch, refer to **Specifications**, in **Section 3**.

SUN SPORT

Typical Twin Engine Battery Switch—In twin engine applications, the port engine START battery doubles as the auxiliary (12 volt accessories) power source. The starboard engine START battery is solely used to start the starboard motor. To turn the battery ON, depress the top portion of the START switch. To turn the battery OFF, depress the bottom portion of the START switch.

Note: Power is supplied to the bilge pumps, high water alarm, stereo memory, and galvanic protection system through the constant power circuit, independent of the battery switches' positioning (i.e., these components receive power even with the switches in the OFF position).

Each twin engine boat is equipped with a battery parallel system (**Figure 4-37**). The battery parallel switch allows you to start either engine off of either battery. The switch should be in the OFF position during normal use. Should one of the START batteries be low on cranking power, turn the battery parallel switch ON. This allows the engine with the low battery to start by using power from the other engine's battery. Once both engines are running, turn the battery parallel switch OFF. If you continue to have a low battery problem, please contact your Formula dealer.

For the location of the battery selector switches, refer to **Specifications**, in **Section 3**.

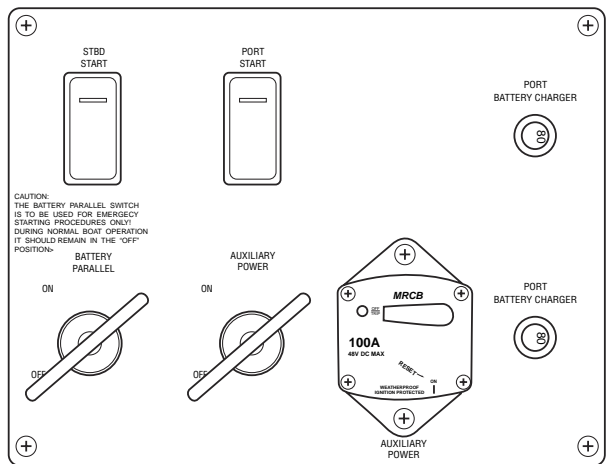

Typical Twin Engine Battery Switch
Figure 4-37



Section 5

System Operation and Equipment

This section describes the basic operational principles of major systems and equipment.

Depending on the model, your Formula boat's powertrain consists of one or two stern drive propulsion units. The engines may be gasoline or diesel fueled.

⚠ WARNING

Regularly inspect and maintain all systems to prevent unexpected hazards associated with worn or faulty components. When replacement parts are required, use marine grade parts with equivalent characteristics, including type, strength and material. Using substandard parts could result in injury and product failure.

POWERTRAIN

Your Owner Information Binder includes the operator's manual for your propulsion units. All operation, specifications and maintenance information for your engine(s) is in this manual. Be sure to read, understand and follow the safety, operating and maintenance information.

Some Formula boats have counter-rotating propellers. A right-hand propeller is installed on the starboard drive and a left-hand propeller is on the port drive. Counter-rotating propellers increases your ability to maneuver by the use of differential power.

FUEL SYSTEM

⚠ WARNING

Check your fuel system before each operation. Have your fuel system thoroughly checked at least once a year by a certified Formula service technician. Gasoline is highly flammable. Use extreme caution at all times.

The line between the fuel tank and the fuel inlet of the engine is made of a synthetic material. Alcohol can deteriorate it, especially during periods of storage. Have your Formula dealer inspect this fuel line at least annually and replace, if necessary.

The generator and engines share the fuel from the tank. The generator fuel pick-up is shorter than the engine pick-up to ensure there is fuel to run the engines to get back to shore. Refer to **Specifications**, in **Section 3**, for the fuel tank capacities.

Refer to your propulsion unit operator's manual for additional fuel system information.

HELM SYSTEM

The helm (steering) system is not self-centering. Be sure to keep a sure grip on the steering wheel at all times.

Your Formula boat is equipped with power steering. A mechanical cable connects the steering wheel to a hydraulic cylinder mounted on the engine. A hydraulic pump is also mounted to the engine. The pump has two hoses running to the hydraulic cylinder giving it power assist. Movement of the hydraulic cylinder controls both drive units.

SUN SPORT

BILGE AND BLOWER SYSTEM

NOTICE

The Federal Water Pollution Control Act prohibits the discharge of oil or oily waste into the water. Violators can be fined \$5,000.00.

Water will enter the boat under a number of adverse conditions such as heavy seas, strong storms and long periods of rain. The bilge is the deepest part of the hull where the water settles. The bilge pump(s) removes the collected water from the bilge through an opening in the hull. Most bilge pumps are automatically operated by a switch that monitors the level of water in the bilge. The bilge pump system is designed to function automatically when the battery switches are in the OFF position. The bilge pump can also be manually operated by a switch located at the helm, provided the system is supplied with power (the house battery switch is ON).

CAUTION

Do not allow the bilge pump to operate after all the water has been cleared from the bilge area. Damage to the pump will occur if the pump is allowed to operate without water.

Bilge blowers ventilate the engine compartment. The blowers are controlled by a switch at the helm or from a switch on the generator panel of the DC control panel.

⚠ WARNING

Operate the blower for at least four minutes each time you start the engines. In addition, the blower should be operated continuously when at idle and during slow speed operation. Failure to operate the blower can cause an explosion.

DC ELECTRICAL

Your Formula boat has a battery powered 12-volt negative ground DC system. The positive wire is hot, and feeds current from the batteries to all 12-volt equipment; the negative wire is the ground and completes the circuit back to the battery.

Models Without Shore Power

Single engine application: Until the engine is running, all DC electrical power is supplied by the auxiliary/start battery. Once the engine is running, the DC electrical power is provided by the engine alternator. The alternator provides more power as the engine speed increases. When the engine is operating, the alternator is also charging the battery.

Twin engine application: The starboard battery supplies power only to the starboard engine. All DC Power is still provided by the port auxiliary/start battery. Once the engine is operating above 1200 RPM, the engine's alternator provides the electrical power, which continues to increase as the engine speed rises. The alternator also charges the respective engine's battery. Refer to **Battery Selector Switches** in **Section 4**.

Note: In twin engine applications, if the use of DC equipment has depleted the power in the battery to the point it will not start the port engine, the following procedure must be used. Start the starboard engine, engage the Battery Parallel switch and start the port engine. Once the port engine is running, disengage the parallel switch.

Note: Power is supplied to the bilge pumps, high water alarm, galvanic protection system and stereo memory, through the constant power circuit, even with the battery switch turned "OFF."

Models With Shore Power

The cabin DC panel distributes power through the main circuit breaker which in turn supplies electricity to operate the:

- CO Detector
- Interior Lights
- Waste Pump
- Refrigerator
- Stereo
- Fresh Water Pump
- 12-volt Outlets

A 100-amp circuit breaker labeled AUXILIARY POWER protects the DC electrical system from the batteries to the DC control panel. Refer to **Specifications**, in **Section 3**, for location of the circuit breaker.

SYSTEM OPERATION AND EQUIPMENT

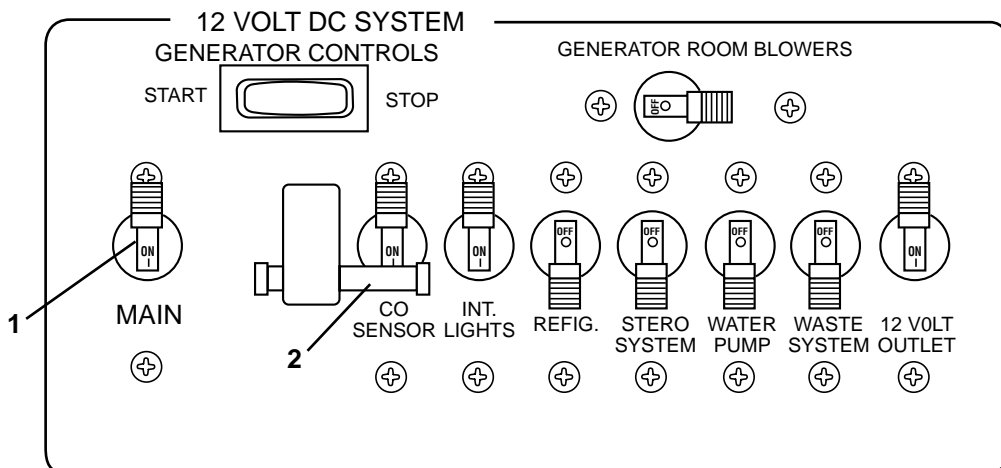

FOR140

1. DC Main Circuit Breaker
2. CO Detector Circuit Breaker

DC Electrical Panel
Figure 5-1

The 12 VDC system consists of a 30-amp main circuit breaker and a series of switch-type circuit breakers, including a dedicated circuit for the CO detector.

The CO detector (sensor) circuit breaker must be in the ON position at all times with the slide lock engaged. Only disengage the slide lock and turn OFF the CO detector circuit breaker during long periods of storage.

To operate the 12 VDC system:

- Turn ON the DC main circuit breaker.
- Activate the individual component circuit breaker.

12-Volt Accessory Power Receptacle—Your Formula is equipped with a 12-volt accessory power receptacle(s). The receptacle provides electricity to operate 12 VDC accessory items.

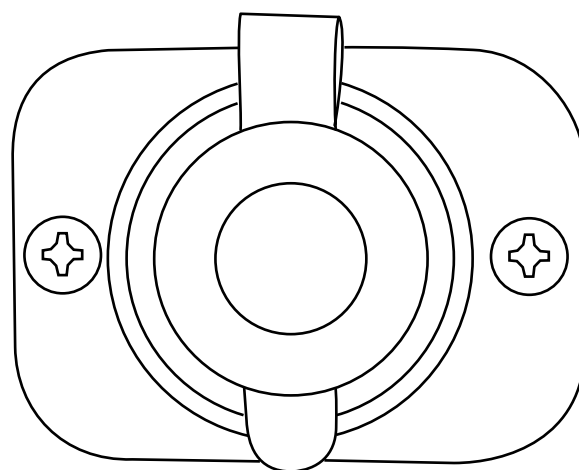

FOR087

12-Volt Accessory Power Receptacle
Figure 5-2

AC ELECTRICAL

CAUTION

Any modification performed on the boat's AC system must be made by a qualified marine technician. The modification must be checked to assure compliance with ABYC guidelines and National Electrical Codes.

SUN SPORT

If your boat is equipped with shore power, the AC portion of the control panel receives AC power from the shore power cable or the generator. The AC panel distributes power through the shore power switch or the generator power switch which in turn supplies electricity to the individual branch circuit breakers.

AC electricity operates the following equipment:

- Electrical Outlets
- Refrigerator
- Battery Charger
- Hot Water Heater
- Air Conditioning

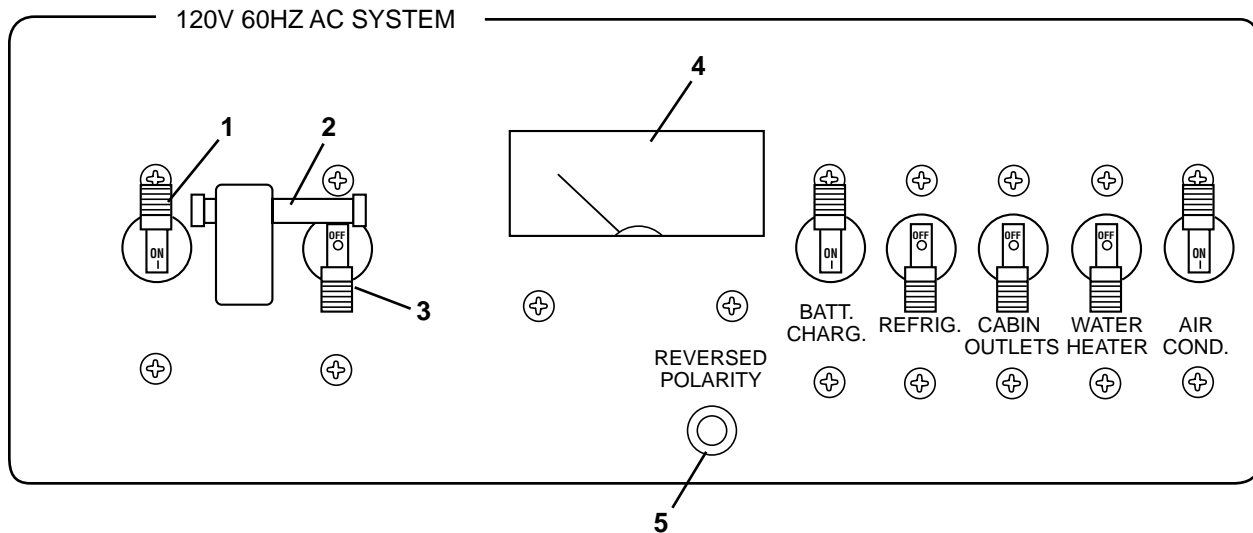

FOR141

1. Shore Power Switch
2. Lock

3. Generator Power Switch
4. Voltmeter

5. Reverse Polarity Light

AC Electrical Panel
Figure 5-3

The voltmeter monitors the AC voltage. Damage can occur to your equipment if the voltage is less than 105 volts. Do not use AC powered equipment if voltage is less than 105 volts.

The shore power switch is also a 30-amp main circuit breaker and controls individual component circuit breakers. This allows you to check for proper voltage and polarity immediately after making the shore power cable connection without damaging any equipment.

The reversed polarity light indicates if the polarity of the shore power has been reversed.

⚠ WARNING

If the reverse polarity light is activated, immediately disconnect the shore power cable.

SYSTEM OPERATION AND EQUIPMENT

SHORE POWER

⚠ WARNING

To minimize shock and fire hazards:

- Turn the AC main circuit breaker OFF before connecting or disconnecting shore cable.
- Connect the shore power cable at the boat first, then to the dockside connection.
- If the reverse polarity light is activated, immediately disconnect shore power cable.
- Disconnect shore power cable at shore outlet first.
- Do not alter shore power cable connections.

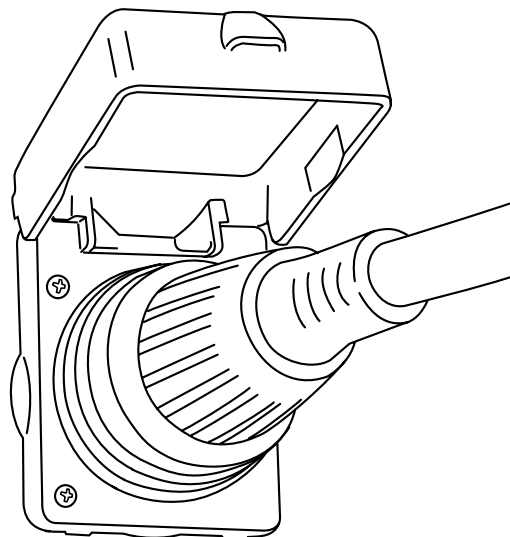

FOR143

Shore Power Receptacle
Figure 5-4

When the shore power cord is plugged in and the shore power switch is in the ON position, all AC equipment can be operated.

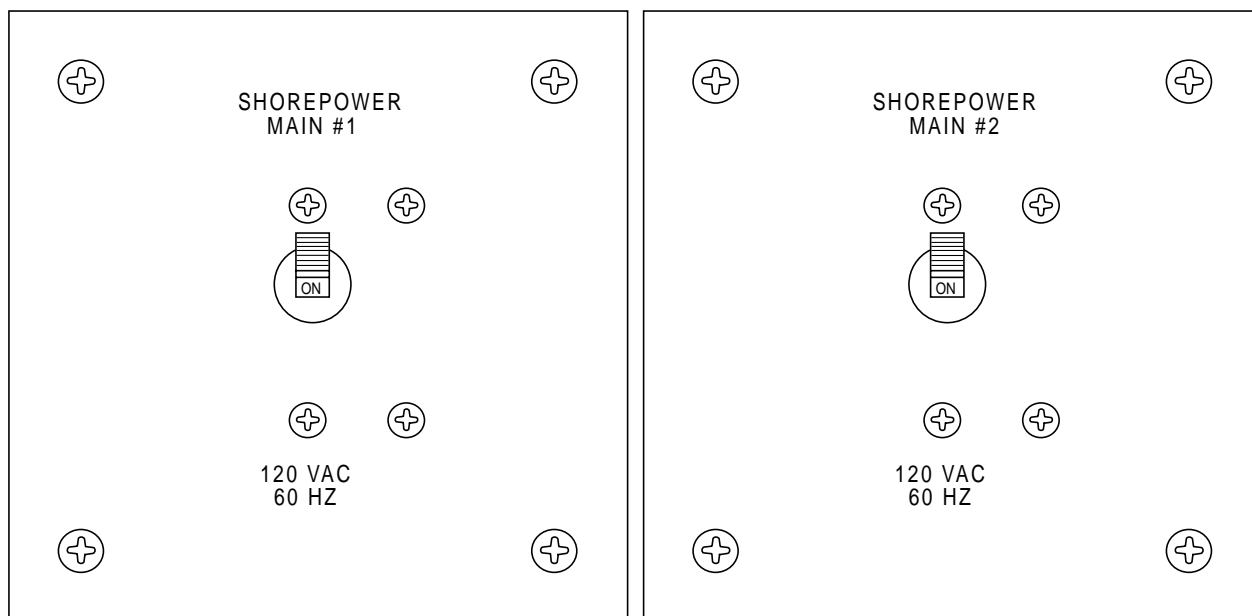

FOR142

Shore Power Inlet Breaker
Figure 5-5

A shore power inlet breaker protects the AC circuit from the boat's shore power connector to the AC control panel. Refer to **Specifications**, in **Section 3**, for shore power inlet breakers' location.

SUN SPORT

Shore Power Connection

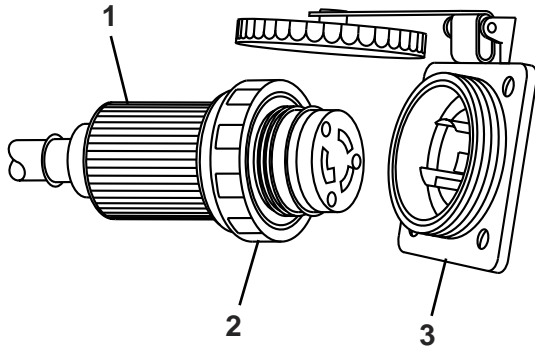

FOR078

1. Shore Power Cord
2. Threaded Locking Collar
3. Boat Receptacle

Shore Power Connection
Figure 5-6

The shore power system requires a special, marine grade three-conductor cable to make a proper connection to the shore. Dockside connections and the boat side connections are plug-in. Boatside connections are also locked in position with a threaded locking collar to prevent accidental disconnection and to enhance water resistance. Refer to **Specifications**, in **Section 3**, for the location of your shore power receptacles.

⚠ WARNING

Plugs and receptacles for different systems are designed in non-interchangeable configurations. A plug from one system cannot fit into the receptacle of another system. Do not modify a shore power cable. Use only commercially available adapters for system modification.

To Connect:

1. Turn OFF the generator power switch on the AC control panel. Move the lock over to secure the switch in place.
2. Turn OFF the shore power switch on the AC control panel.

Ensure Shore Power Inlet Breaker(s) (**Figure 5-5**) is switched OFF.

3. If the outlet on the dock has a disconnect switch, turn the switch OFF.

4. Connect the shore power cable at the boat first.
5. Make sure the cable has more slack than the mooring lines.
6. Remove the cap from the outlet on the dock. Connect the cable to the outlet.
7. Turn ON the dock's outlet breaker(s). Turn ON the Shore Power Inlet Breaker(s).
8. Turn ON the shore power switch on the AC control panel. If the reverse polarity light remains ON, immediately turn OFF the shore power switch and disconnect the shore power cable at the shore outlet. Contact your Formula dealer to service the system before you use it.
9. Turn ON the respective branch circuit breakers as needed.

To Disconnect:

1. Turn OFF the shore power switch.
2. If the shore outlet has a disconnect switch, turn it to the OFF position.
3. Disconnect the shore power cord at the shore outlet.
4. Disconnect the cable from the boat and close the cap.

⚠ WARNING

Some marinas have been known to "break" shore power ground circuits to prevent electrolysis. Opening the ground circuit creates a potentially dangerous onboard shock hazard. Use caution when using a "break" shore power ground circuit.

For further information regarding your shore power system, please contact your Formula dealer.

Galvanic Isolator Monitor—The galvanic isolator electrically connects the boat bonding system to the earth. This system prevents the bonding system from becoming electrically "hot." The galvanic isolator monitor checks the galvanic isolator system for proper operation.

Please refer to the Galvanic Isolator Monitor operator's manual located in your Owner's Information Binder for additional information.

SYSTEM OPERATION AND EQUIPMENT

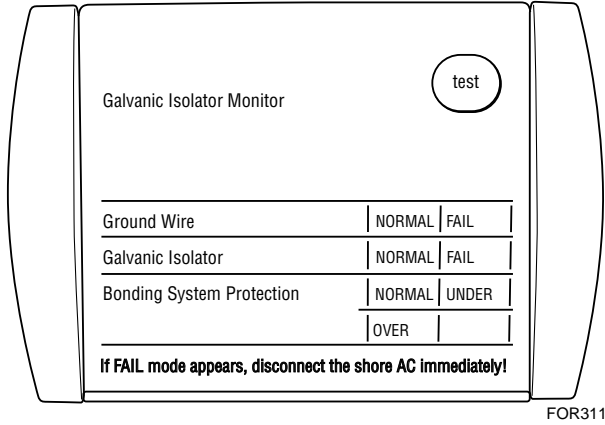

Galvanic Isolator Monitor
Figure 5-7

GENERATOR

⚠ WARNING

Operate the blower for at least four minutes each time before you start the generator.

CAUTION

A diesel power generator may have a preheat switch used during starting. Do not exceed 30 minutes of preheat time or the manifold heater and plugs can be damaged.

⚠ WARNING

Should the display indicate a system failure, immediately disconnect shore power sources (refer to Shore Power – Section 5) and contact your Formula dealer.

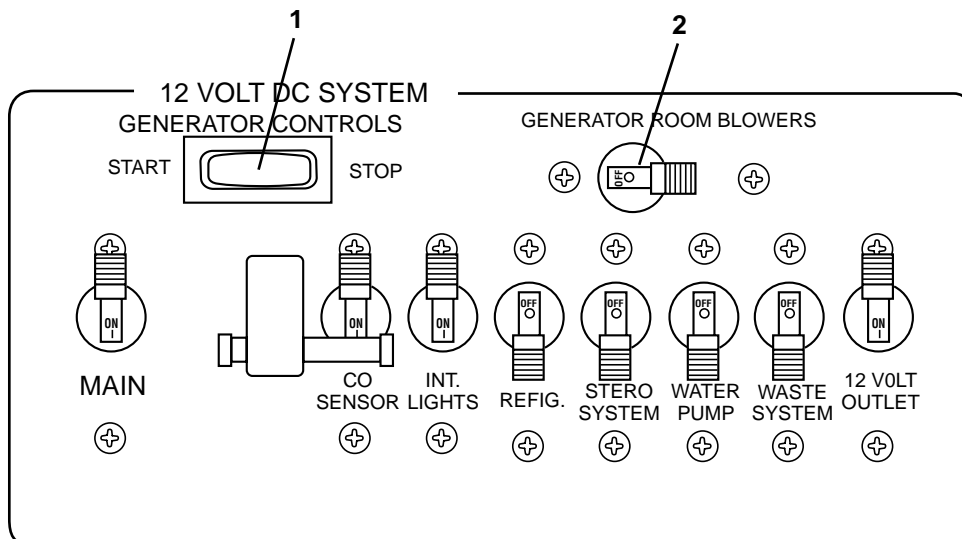

FOR144

1. Start/Stop Switch
2. Blower Switch

Generator Control Panel
Figure 5-8

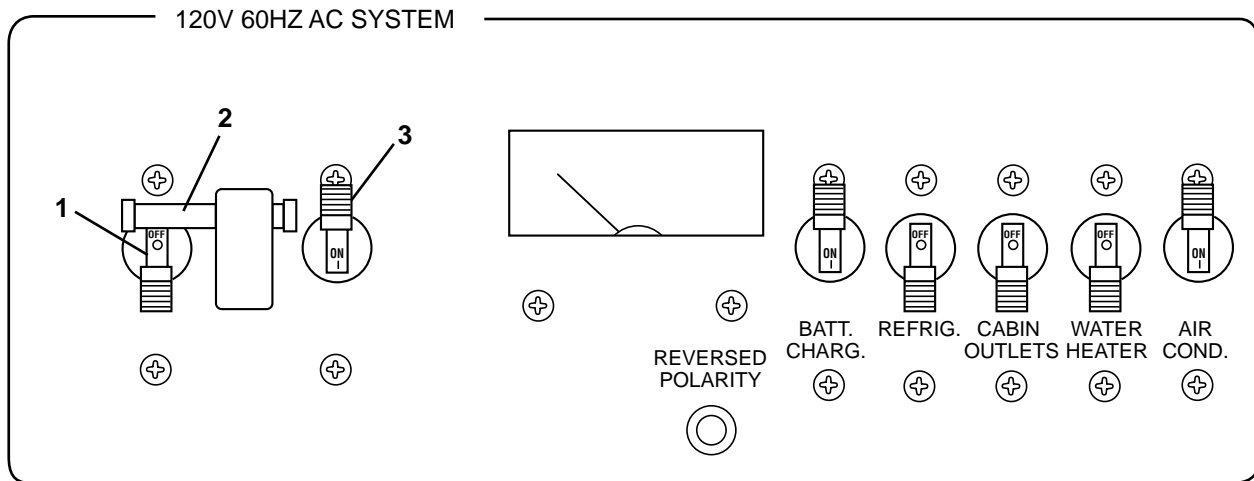

1. Shore Power Switch
2. Lock
3. Generator Switch

FOR145

Shore/Generator Power (A/C) Control Panel

Figure 5-9

The generator controls are mounted on the DC control panel. Both the generator Start/Stop and Blower switches are located there.

The generator is used to provide AC power when shore power is not available.

1. Make sure the generator seacock is open.
2. Turn OFF the shore power switch on the AC control panel. Move the lock over to secure the switch in place.
3. Turn OFF the generator power switch.
4. Turn ON the blower and operate it for at least four minutes.
5. Push the START side of the generator's Start/Stop switch. Allow generator to operate for at least one minute to stabilize voltage.
6. Turn ON the generator power switch.
7. Switch ON the respective branch breakers as needed. In this configuration, all components can be used with power supplied by the generator up to a maximum of 30 amps.
8. Do not operate the generator in conjunction with high speed operation of the boat. The resulting reduction in water flow to the generator could damage the unit's water pump impeller.

⚠ DANGER

Carbon monoxide gas (CO) is colorless, odorless and extremely dangerous. All engines and fuel burning appliances produce CO as exhaust. Direct and prolonged exposure to CO will cause BRAIN DAMAGE or DEATH. Signs of exposure to CO include nausea, dizziness and drowsiness.

Stop the generator by pressing the STOP side of the Start/Stop switch. Close the generator's seacock.

BATTERY CHARGER

Your Formula boat may be equipped with a battery charger located in the engine compartment. Anytime your boat is connected to shore power or the generator is running and the BATTERY CHARGER switch at the AC control panel is ON, the battery charger will operate and act to keep the batteries fully charged. Please refer to the battery charger operator's manual for additional information.

SYSTEM OPERATION AND EQUIPMENT

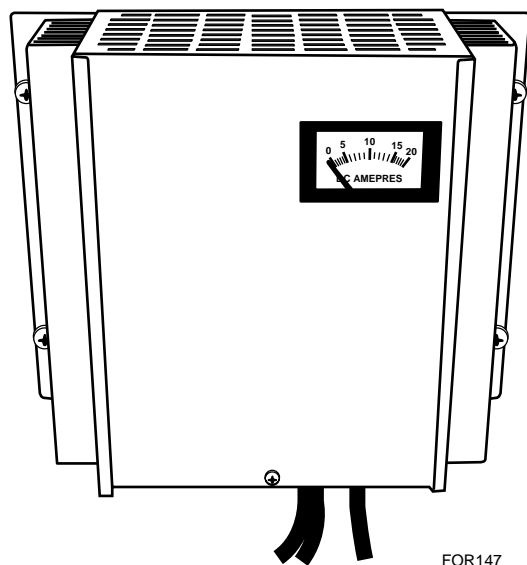

FOR147

Battery Charger
Figure 5-10

INVERTER

Found in Sun Sport models with the optional television, the inverter inverts 12VDC power to 120VAC power. This power is then used to operate the television. The inverter is controlled via a remote mounted control on the forward head wall.

To operate the television, the 120VAC PWR INV C-BKR on the cabin 12VDC panel must be ON.

Please refer to the inverter's operator manual for additional information.

NOTICE

The inverter is meant only to power the television.

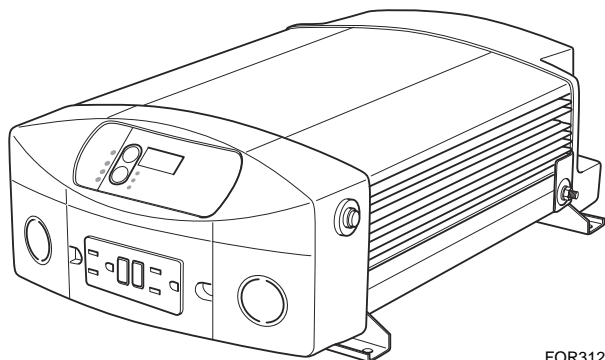

FOR312

Inverter
Figure 5-11

AIR CONDITIONING SYSTEM

Air conditioning systems are available on select Formula models. To operate the air conditioning system:

- Open the air conditioner intake seacock.
- Make sure 110VAC power is supplied to the AIR COND circuit breaker. Turn the AIR COND circuit breaker ON.
- Press the ON/OFF button on the control pad to turn the system ON.
- Use the UP/DOWN arrows to set the desired cabin temperature.
- Check the air conditioner return thru-hull for a solid steady stream of water.
- Check the air supply grille for a steady flow of air.

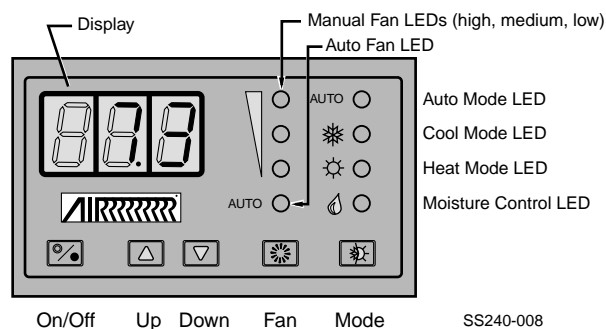

AC Control Pad
Figure 5-12

Periodically inspect the air conditioner intake strainer and filter for signs of debris which may inhibit the cooling abilities of the air conditioning system. For an in-depth description of the operation and maintenance procedures for the air conditioning system specific to your boat, refer to the manufacturer's literature located in the "Systems" section of the Formula Owner Information Binder.

SUN SPORT

FRESH WATER SYSTEM

⚠ WARNING

Before connecting to any water fitting, dockside or otherwise, make sure the water is potable and suitable for human consumption. A special sanitary drinking water hose is required for potable water connection. Do not use common garden hose for drinking water.

The fresh water system provides potable (drinkable) water to the sinks, showers, hot water heater and transom shower if the boat is so equipped. Refer to **Specifications**, in **Section 3**, for the fresh water tank capacity for your model.

The onboard fresh water system is operated by a 12 VDC water pump. To use the vessel's onboard water supply, the 12 VDC system must be activated and the WATER PUMP switch turned ON. Depending on the boat model, the fresh water pump "switch" may be a re-settable circuit breaker.

The water pump works on demand. It will not automatically shut off when the fresh water tank is empty. Monitor the level of water in the tank. If the water pump is allowed to run continuously, it may overheat.

Transom Shower—The optional transom wash-down shower is located at the stern of the boat. The shower model will vary depending on the boat model. The 12 VDC WATER PUMP circuit breaker switch must be ON for the unit to function.

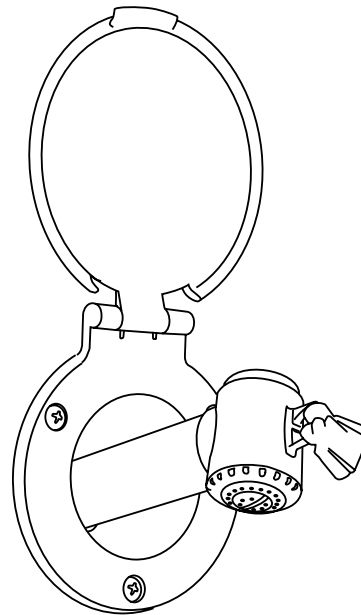

Transom Shower
Figure 5-13

Fresh Water Dockside Hookup

CAUTION

Monitor the fresh water dockside hookup during the initial use. The boat is connected to an unlimited supply of water. Do not leave the boat unattended while using this feature. Any major leak or break in the system will allow continuous water flow into the boat causing severe damage.

A fresh water dockside hookup is available in some models, which allows usage of city water while docked. Refer to **Specifications**, in **Section 3**, for location.

Water supplied through this hookup will not replenish the fresh water supply in the on-board tank. Consequently, the tank can only be filled at the fresh water fill plate.

SYSTEM OPERATION AND EQUIPMENT

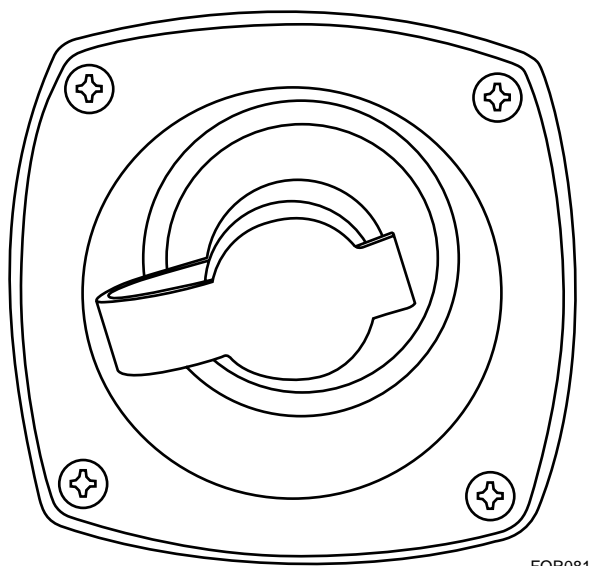

FOR081

Fresh Water Dockside Hookup
Figure 5-14

To connect to city water:

1. Turn the 12 VDC WATER PUMP circuit breaker OFF.
2. Remove the plug from the boat's water inlet fitting.
3. Attach the proper sanitary drinking water hose to the dockside city water outlet. Turn on the water and flush the hose before connecting it to your boat.

GRAY WATER SYSTEM

In some models, the gray water from the sink drains, shower drains and air conditioning condensation drain flows into a shower sump box. When the gray water in the sump box reaches a predetermined level, a switch activates a pump. The water is then evacuated overboard or, in the case of boats with the "gray water" option, into the waste holding tank.

Gray water from the head is also stored in the waste tank. Refer to **Specifications**, in **Section 3**, for waste tank capacity.

WASTE WATER (HEAD) SYSTEM

Your Formula is equipped with one of the three following systems:

- **Portable Head**
- **Manual Marine Head**
- **VacuFlush/Electric Head**

For an in-depth description of the operation and maintenance procedures for the head system specific to your boat, refer to the manufacturer's literature located in the "Systems" section of the Formula Owner Information Binder. The following general information provides the basics of each system's operation.

Portable Head—The portable head unit is a manual flush style head system that does not require 12VDC power. All waste is contained within the waste tank portion of the head unit. Waste can be emptied from the head unit by emptying the waste tank into a permanent toilet facility.

Monitor your waste tank level indicator to know when your tank has reached its full capacity. Never attempt to over fill the waste tank.

After emptying the waste holding tank, recharge the holding tank with the approved waste treatment chemical as detailed in the head unit owner's manual found in your Formula Owner's Information Binder.

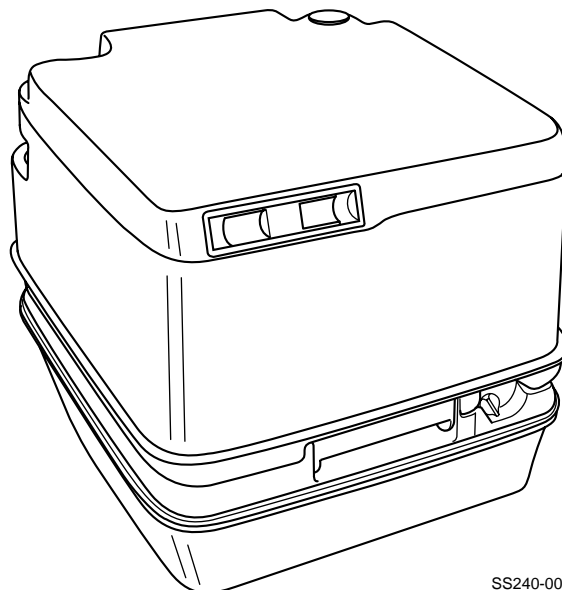

SS240-002

Portable Head
Figure 5-15

SUN SPORT

Manual Marine Head—The manual head unit is a manual flush style head system that does not require 12VDC power. The manual head fresh water seacock must be open in order to add water to the bowl and to flush waste. All waste is contained within the boat's remote waste tank. Waste can be emptied from the head system by having the waste pumped out at a pumping facility.

Monitor your waste tank level indicator to know when your tank has reached its full capacity. Never attempt to overfill the waste tank.

After emptying the waste holding tank, recharge the holding tank with the approved waste treatment chemical as detailed in the head unit owner's manual found in your Formula Owner's Information Binder.

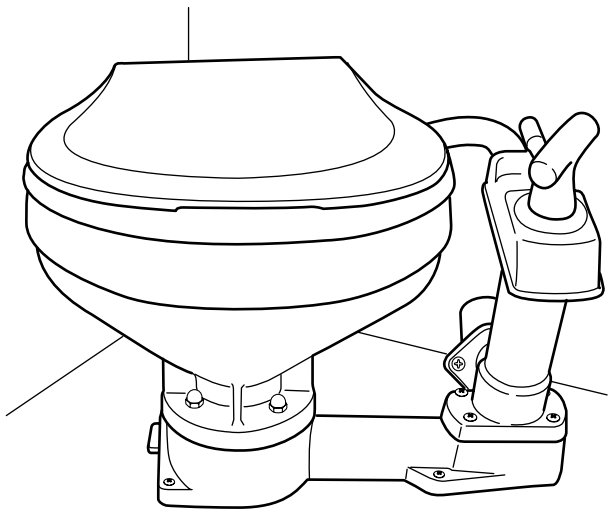

Manual Marine Head
Figure 5-16

VacuFlush Head—The VacuFlush system is active when the 12VDC system is energized and the HEAD PUMP breaker is turned ON. The head pump creates vacuum in the system. When the toilet is flushed, the stored vacuum clears the bowl of waste. The vacuum pump will run for a few minutes after flushing to restore vacuum in the system. The pump will then automatically shut off upon reaching the set vacuum level.

The WATER PUMP breaker on the 12VDC panel must be turned ON (not necessary if the boat is connected to a dockside water supply). This provides the water needed for flushing.

Monitor your waste tank level indicator to know when your tank has reached its full capacity. Never attempt to overfill the waste tank.

Please note: Your head system is equipped with a safety mechanism that shuts down the head pump, not allowing the toilet to flush when the tank FULL level light is illuminated. This safety measure prevents overfilling the waste holding tank.

After emptying the waste holding tank, recharge the holding tank with the approved waste treatment chemical as detailed in the head unit owner's manual found in your Formula Owner's Information Binder.



VacuFlush/Electric Head
Figure 5-17

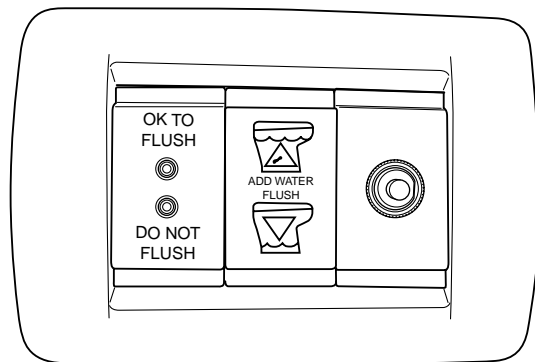

Electric Head
Figure 5-18

SYSTEM OPERATION AND EQUIPMENT

Macerator Discharge Pump—The optional macerator system allows the discharging of waste water directly overboard through a thru-hull located in the engine bilge. The macerator system is active when the 12VDC system is energized and the WASTE TREATMENT breaker is turned ON. The macerator seacock must be open and the Y-valve flow directed towards the macerator in order to discharge waste. Activate the macerator by pressing and holding the macerator switch located in the head compartment until the tank has reached the empty level. The macerator switch operates independently of the seacock or Y-valve's position.

CAUTION

Overboard discharge of waste water is prohibited in many areas. It is your responsibility to comply with local regulations regarding the discharge of waste. You could be fined if your boat has an operable overboard discharge system. Removing the handle of the seacock while in closed position, or disabling the system by other means may be required to avoid a fine.

RAW WATER SYSTEM

Your Formula boat may have as many as two accessory components (generator and air conditioning) - in addition to the engines - with complete raw water systems.

Each raw water system will have its own thru-hull water intake, seacock and strainer. The seacock is very important. It protects the boat from sinking if a hose or fitting should fail. It is important to close any seacock not in use.

Waste water from the generator is routed with the generator's exhaust system. Waste water from the air conditioning unit is directed overboard through a drain port in the hull.

Your engines have their own raw water system for cooling. Refer to the propulsion unit operator's manual for engine cooling information.

AUTOMATIC FIRE EXTINGUISHER SYSTEM

A fixed automatic fire extinguisher that uses FE-241 (FM-200 for European requirements) as an extinguishing agent is mounted on the engine compartment forward bulkhead. The extinguisher

is activated when the heat sensitive head reaches a predetermined temperature. The extinguisher discharges and saturates the engine compartment, smothering the fire.

⚠ WARNING

When the fire extinguisher discharge occurs, turn OFF all engines, bilge blowers and electrical system components. Refrain from opening the engine compartment hatch, as the introduction of oxygen could accelerate any fire present there.

Allow the extinguishant to soak for 15 minutes after it discharges. With a portable fire extinguisher in your hand, cautiously inspect for damage. Avoid breathing fire vapors or fumes.

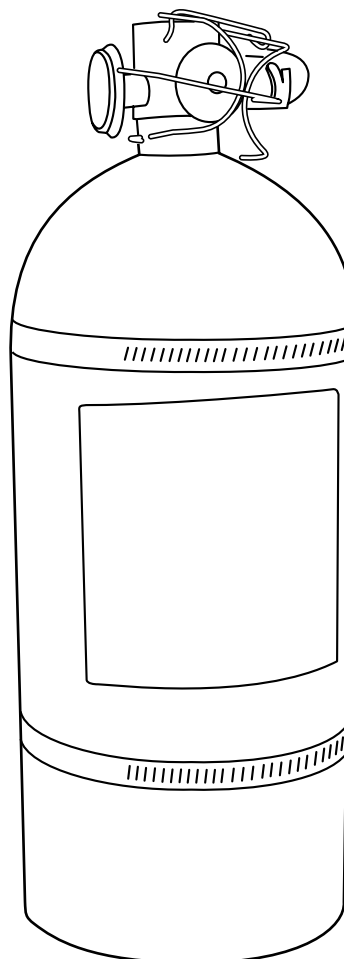

FOR021

**Automatic Fire Extinguisher
Figure 5-19**

Refer to **Automatic Fire Extinguisher Indicator**, in **Section 4**, for information on the automatic fire extinguisher monitoring indicator.

SUN SPORT

EQUIPMENT

Ski Pylon—240 BR and 260 BR/SS only

The ski pylon is used during water sport activities. Rotate the pylon clockwise to lock it into the pylon base. A magnetic read switch prevents the engine hatch from being opened while the pylon is installed.

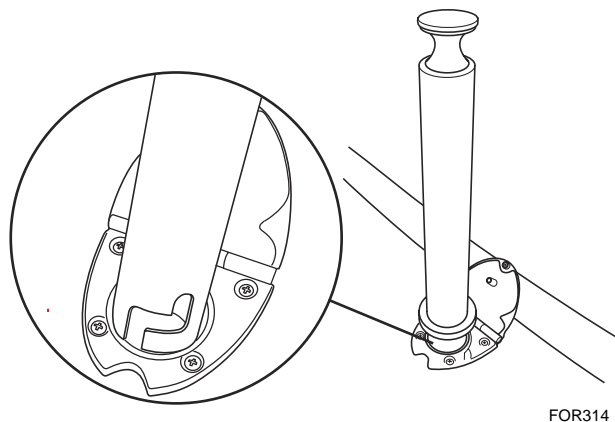

Ski Pylon
Figure 5-20

Boarding Ladder—The boarding ladder is mounted on the swim platform at the stern of the boat. In most applications, a fiberglass lid covers the stowed ladder. Lift this lid to access the ladder.

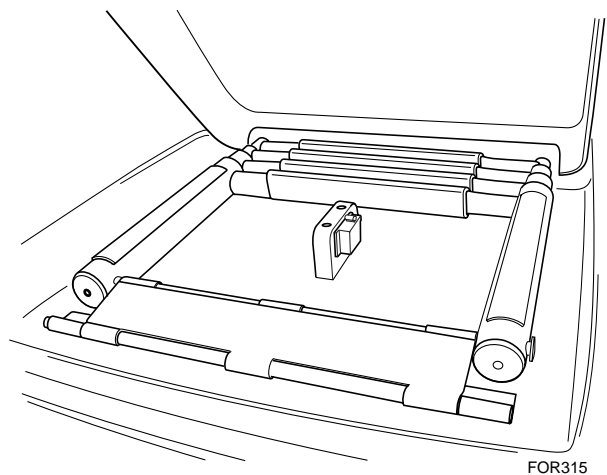

Boarding Ladder
Figure 5-21

Bow Ladder—240 BR only

The bow/beach ladder is mounted at the bow of the boat. A fiberglass lid covers the stowed ladder. Lift this lid to access the ladder.

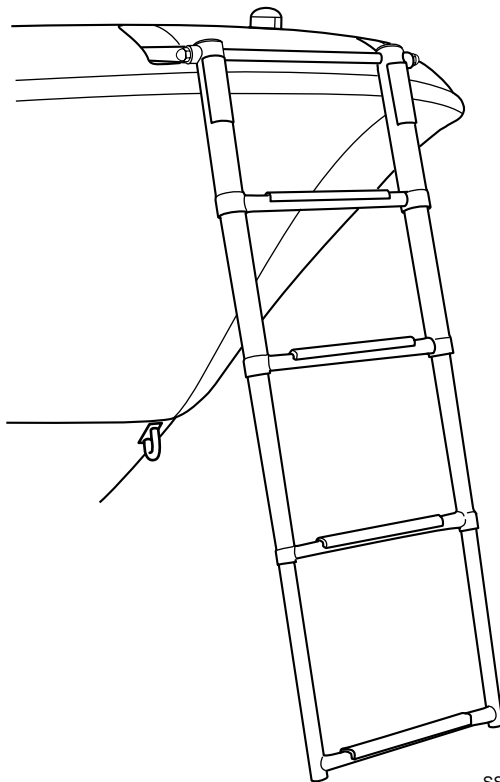

Bow Ladder
Figure 5-22

Pedestal Seat—240 BR only

Your captain's and passenger's pedestal seats have a flip-up forward cushion for greater visibility and maneuverability while docking. You can sit on the raised cushion or stand in front of the cushion. To raise the cushion, simply pull up on the cushion. To lower the cushion, push down.

The pedestal seats also swivel. To swivel the seat, raise the lever found under the forward portion of the seat. Lower the lever to lock the seat in place.

Standing while driving your boat should only be attempted by an experienced driver, and then only while maneuvering at an idle speed.

SYSTEM OPERATION AND EQUIPMENT

⚠ WARNING

The captain's pedestal seat should be in a forward facing position whenever the boat is underway. Both seats should be in a locked position whenever the boat is underway.

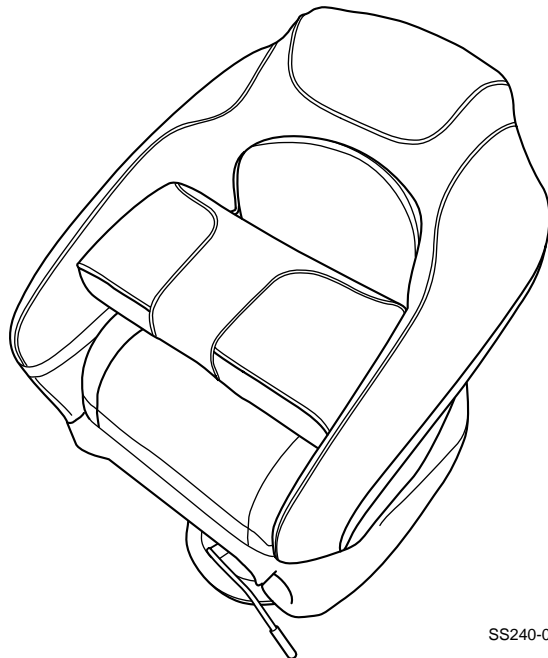

Pedestal Seat
Figure 5-23

Sun Lounge

The aft seat backrest folds forward to create an expansive sun lounge.

CAUTION

To avoid serious injury, do not occupy aft facing lounge with engine(s) running.

240 BR

To fold the backrest forward, pull the locking pin located on the starboard side of the backrest. The backrest is now free to fold forward. With the backrest lowered, reinstall the locking pin. Lower the forward engine hatch cushion by lifting its forward edge. Doing so will allow you to release the cushion's support and to lay it flat.

310 SS

To release the backrest:

1. Pull the strap found at the bottom of the engine hatch.
2. The backrest is now free to fold forward.
3. Lift the center cushion and lay it flat.

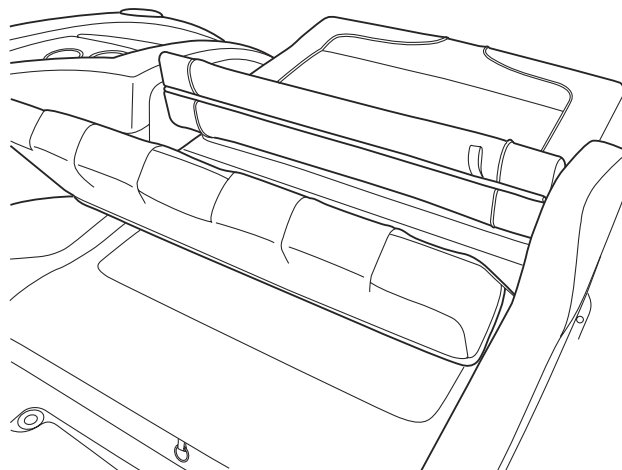

FOR322

Sun Lounge
Figure 5-24

Helm Seat—Your captain's chair and passenger's chair have a flip-up bolster position for greater visibility and maneuverability while docking. You can sit on the raised cushion or stand in front of the cushion. Standing while driving your boat should only be attempted by an experienced driver, and then only while maneuvering at an idle speed.

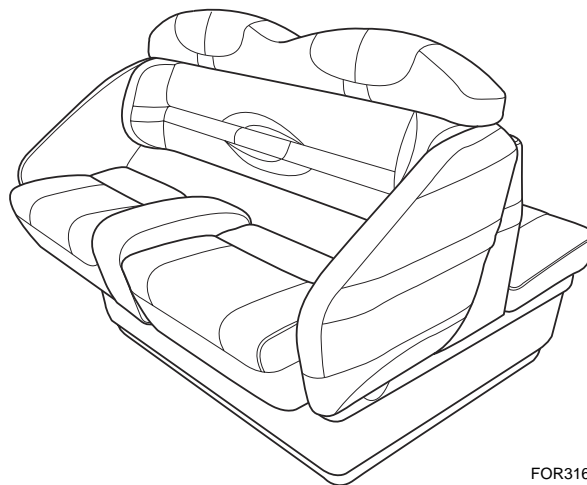

FOR316

Helm Seat
Figure 5-25

SUN SPORT

To raise the bolster, push aft on the front edge of the cushion, and then pull up. To lower the bolster, pull up on the front edge of the cushion, then push down.

Cabin Access Door—Whenever practical, secure the door in the open position (see door stop, **Figure 5-26**) before operating boat.

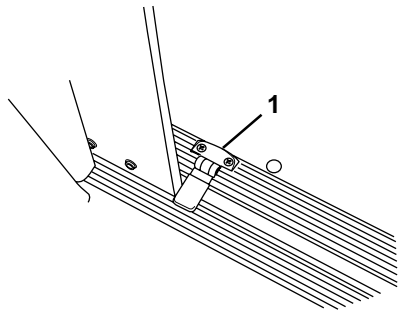

FOR030

1. Door Stop

Cabin Access Door
Figure 5-26

Global Positioning Satellite (GPS)—At least two GPS options are available in your Formula boat – a standalone GPS receiver and a combination GPS/Chartplotter. A GPS provides precise information regarding a vessel's location and speed and can also be used to plan and record trip routes. The chartplotter provides additional navigation capabilities, including the use of digitized charts for specific boating areas, which can be purchased in chip format. Refer to the manufacturer's owner manual in the Formula Owner Information Binder for specific information relative to your boat's GPS or GPS/Chartplotter.

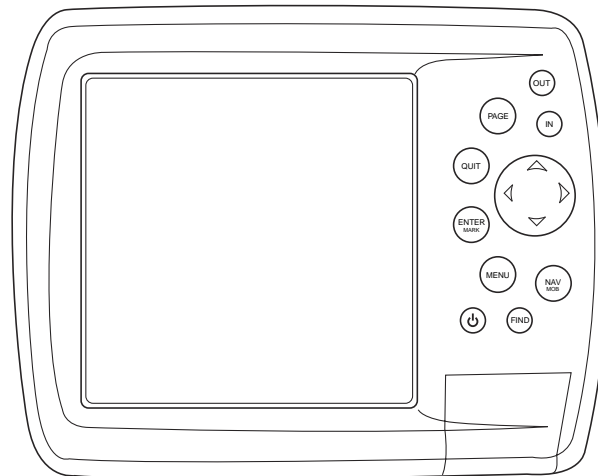

FOR317

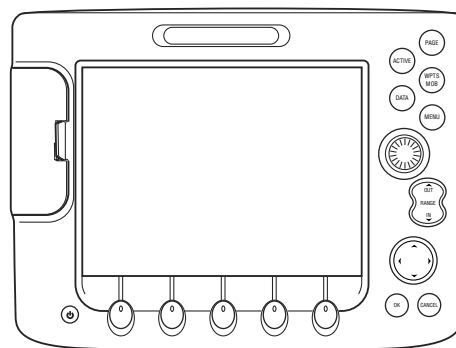

FOR318

(GPS/Chart Plotter)
GPS Unit
Figure 5-27

SYSTEM OPERATION AND EQUIPMENT

Stereo Auxiliary Input

2.5 mm Auxiliary Input— Located at the helm, this input allows you to connect an external audio device, such as an MP3 player, via a 2.5 mm audio cable (not supplied) to the AUX source on the factory-installed stereo system.

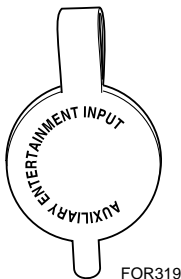

2.5 mm Auxiliary Input
Figure 5-28

iPod™ Cradle (optional)— Located in the cabin, this input allows you to connect an Apple iPod™ (not supplied) directly to the AUX source on the factory-installed stereo system. While docked, iPod™ playlist and media information is displayed on the stereo head unit. Docking the iPod™ also allows the unit to be charged.

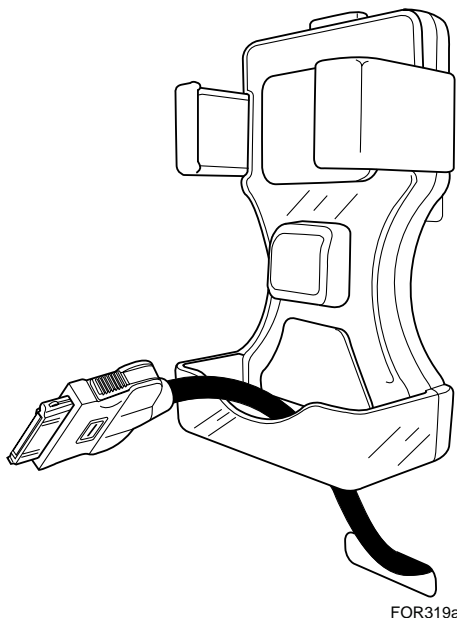

iPod™ Cradle
Figure 5-29

Hot Water Heater— Formula equips some models with an on-board water heater, which operates on 110V AC power. To operate the water heater, the AC/DC panel must be supplied with 110V power and the AC panel switch labeled WATER HEATER must be ON. To avoid damaging the water heater element, the water heater tank must be full before turning the unit ON.

NOTICE

A “passive” means for heating onboard water is accomplished via plumbing between the engines and the water heater. Whenever the engines are operated, water contained within the water heater will be heated by circulating engine coolant. Refer to your Formula Owner Information Binder for specific instructions and information pertaining to this accessory as described in the manufacturer’s literature.

Water heaters unused for more than two weeks may produce hydrogen gas.

To reduce the risk of injury under these conditions, open the hot water faucet for several minutes at the galley sink before you use any electrical appliance connected to the hot water system.

⚠ WARNING

Do not smoke or have any flame near an open faucet; hydrogen gas is extremely flammable.

If hydrogen is present, you probably will hear unusual sounds like air escaping through the pipe as water begins to flow. Allow the water to flow until these sounds disappear.

Microwave Oven—Your Formula boat may be equipped with a microwave oven. Since the unit operates on 110V power, the AC side of the AC/DC panel must be energized and the AC switch labeled MICROWAVE turned ON for the accessory to function. Please refer to the respective owner manual in the Formula Owner Information Binder for information specific to this unit.

CAUTION

Remove the microwave’s interior glass dish while boat is underway.

SUN SPORT

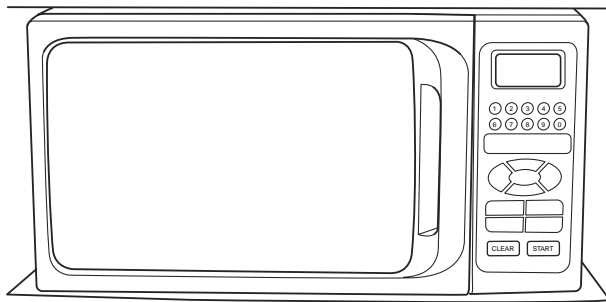

FOR320

Microwave
Figure 5-30

Refrigerator—The dual electric refrigerator can be operated from both the 110 VAC system and the 12VDC system.

- When operating the refrigerator using the 12 VDC system, the REFRIGERATOR circuit breaker on the DC control panel must be ON, and the REFRIGERATOR circuit breaker on the AC control panel must be OFF.
- When operating the refrigerator using the 110 VAC system, the REFRIGERATOR circuit breaker on the AC control panel must be ON, and the REFRIGERATOR circuit breaker on the DC control panel must be OFF.

The thermostat control is inside the refrigerator. Refer to the refrigerator operator's manual in your Owner Information Binder.

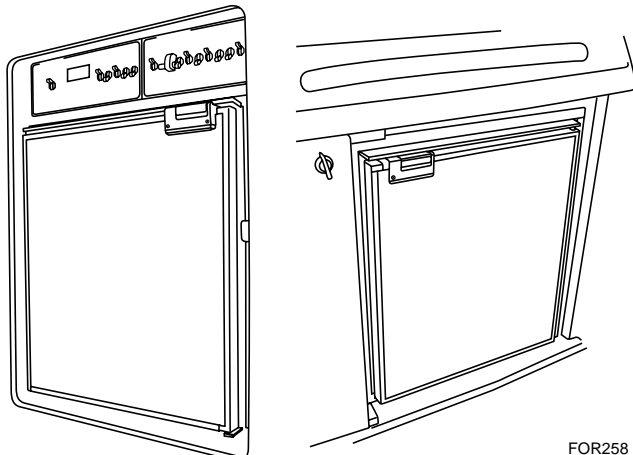

(Cabin)

(Cockpit)

FOR258

Refrigerator
Figure 5-31

Stove—Your Formula boat may be equipped with the optional Cockpit Alcohol Stove. Please refer to the respective owner's manual in the Formula Owner Information Binder for information specific to this unit.

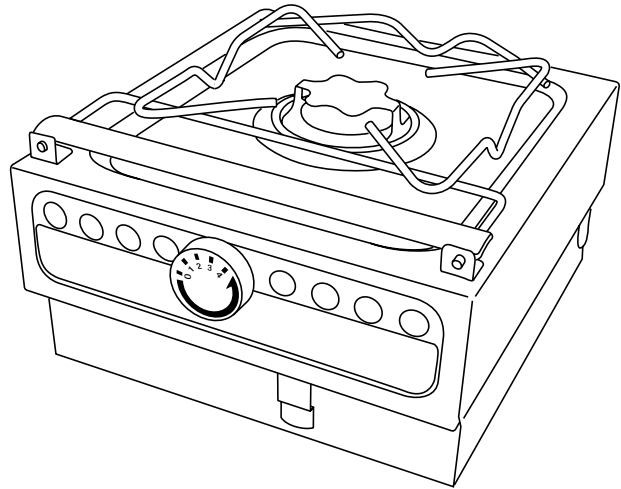

FOR259

Stove
Figure 5-32

VHF/FM Marine Radio—Provides reliable communications between boats, and between a boat at sea to public and private shore stations. For operating information, refer to the radio owner's manual in your Owner Information Binder.

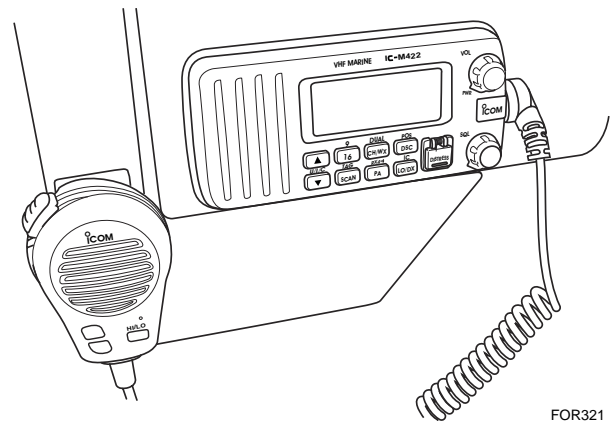

FOR321

VHF/FM Marine Radio
Figure 5-33



Section 6

Getting Underway

There are many things to consider to make your boating trip safe and enjoyable. You are responsible for the safety of all passengers, the boat and any damage the boat or its wake may cause. Keep passengers from blocking your view so that you do not run into other boats, swimmers, water skiers, personal water vehicles or aids to navigation.

SAFETY CHECKLIST

⚠ WARNING

Do not operate the boat if any problem is found during this inspection. A problem could lead to an accident during the outing causing severe injury or death. Problems found during this inspection should be handled by your Formula dealer.

The following checks are essential to safe boating and must be performed before starting the engines.

- Check the weather report, wind and water conditions.
- Check that required safety equipment is onboard and in proper operating condition.
- Check that fire extinguishers are fully charged.
- Test operation of the carbon monoxide detectors.
- Be sure the boat is not overloaded.
- Check that all maintenance has been performed.

BASIC SAFE BOATING RULES

The General Prudential Rule regarding right-of-way is that if a collision appears unavoidable, neither boat has right-of-way. As prescribed in the "Rules of the Road," both boats must act to avoid collision.

The information in this section outlines only the most basic of the nautical rules of the road. For more information, contact your local USCG Auxiliary.

⚠ WARNING

The nautical rules of the road must be followed to prevent collisions between vessels. Like traffic laws for automobiles, the operator is legally required to follow the rules.

NOTICE

In general, boats with less maneuverability have right-of-way over more agile craft. You must stay clear of the vessel with right-of-way and pass to his stern.

Signaling other boats with a whistle or horn is similar to using turn signals on an automobile. It is not necessary to sound a signal every time a boat is nearby. In general, boat operators should signal their intention to avoid potentially confusing or hazardous situations.

SUN SPORT

It is customary for the privileged boat to signal first, and the give-way boat to return the same signal to acknowledge she understands and will comply. Use the danger signal (five or more short and rapid blasts) if intent is not clear.

Use the following signal blast early enough to be noticed and understood by other boaters:

- One long blast: Warning signal (coming out of slip or passing astern)
- One short blast: Pass on my port side
- Two short blasts: Pass on my starboard side
- Three short blasts: Engines in reverse
- Five or more short and rapid blasts: Danger signal!

Privileged Boats

Privileged boats have right-of-way and can hold course and speed. Sailboats and boats paddled or rowed have the right-of-way over motor boats. Sailboats under power are considered motorboats. Small pleasure crafts must yield to large commercial boats in narrow channels.

Burdened Boats

The burdened boat is the boat that must make whatever adjustment to course and speed necessary to keep out of the way of the privileged boat.

Crossing Situation

In crossing situations, the boat to the right from the 12 o'clock to the 4 o'clock position has the right-of-way. It must hold course and speed. The burdened boat keeps clear and passes behind the privileged boat. Boats going up and down a river have the privilege over boats crossing the river.

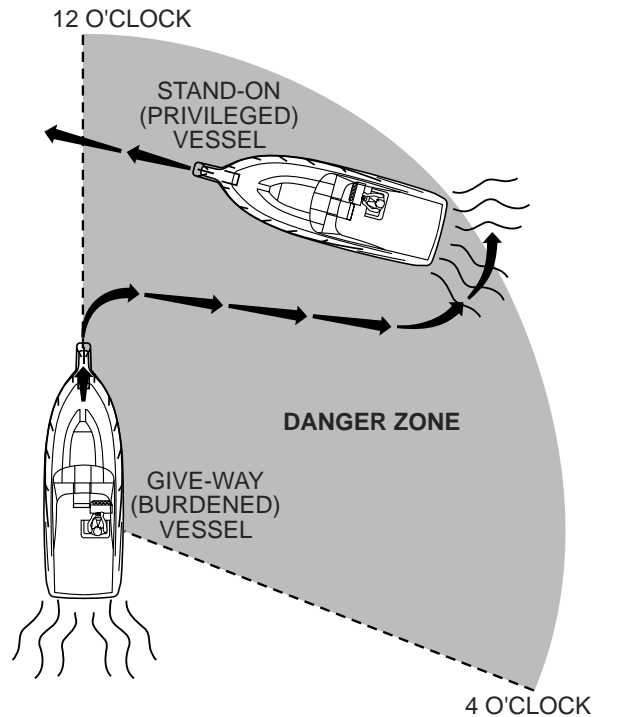

Crossing
Figure 6-1

KC-0477

GETTING UNDERWAY

Meeting Head-On

Neither boat has the right-of-way in this situation. Both boats should decrease speed, turn to the right, and pass port-to-port. However, if both boats

are on the left side of the channel, each vessel should sound two short blasts and pass starboard-to-starboard.

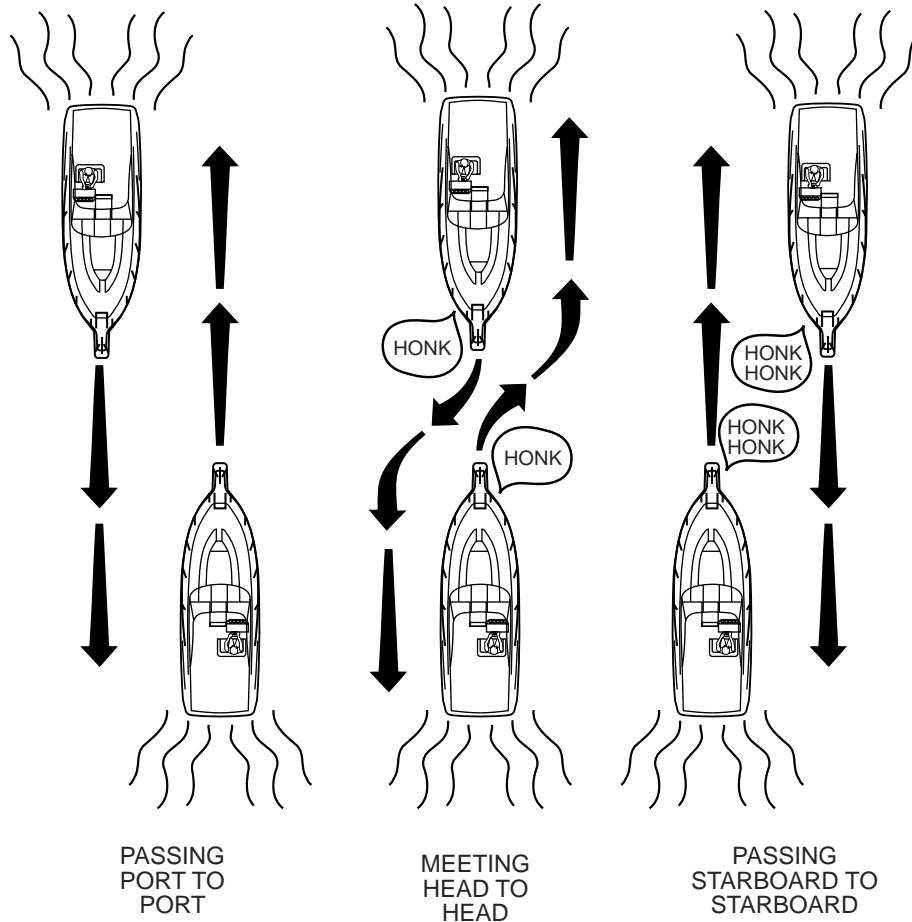

Meeting Head-On
Figure 6-2

KC-0475

SUN SPORT

Overtaking

The boat that is overtaking one ahead of it is the give-way boat and must make any adjustments necessary to keep out of the way of the stand-on boat. The stand-on boat should hold its course and speed.

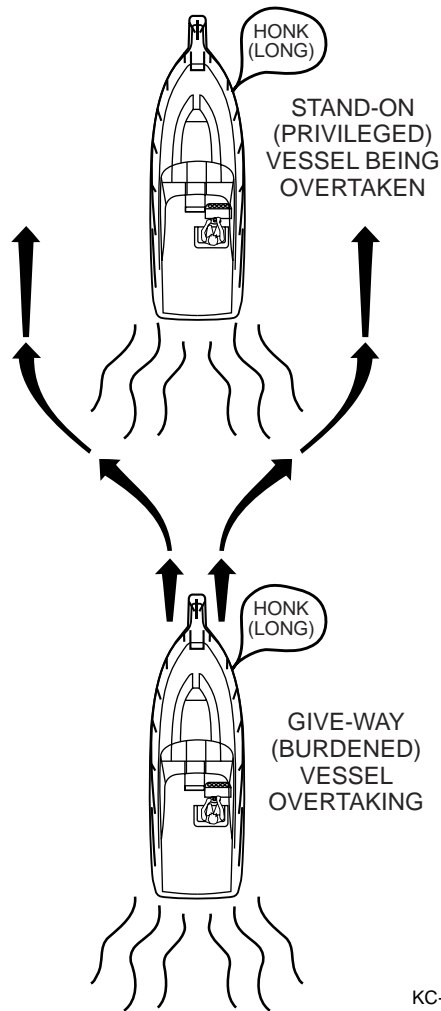

Overtaking
Figure 6-3

KC-0476

FUELING

⚠ DANGER

Gasoline is extremely flammable and highly explosive under certain conditions. Stop the engines and generator, and do not smoke or allow open flames or sparks within 50 feet (15 meters) of the fueling area.

⚠ WARNING

All precautions must be taken every time you fuel your boat, whether it's gasoline or diesel fuel. Diesel fuel is non-explosive, but it will burn.

CAUTION

To prevent unwarranted engine damage, refer to your propulsion unit operator's manuals for recommended fuel type and octane rating.

Take care not to spill gasoline. If gasoline is accidentally spilled, wipe up all traces of it with dry rags and immediately dispose of the rags properly ashore. Spilled fuel may yellow the gelcoat finish, damage gunwale trim and discolor Imron.

When fueling:

1. Know your fuel tank capacity. Be sure to have enough fuel to reach your destination. If departing for an extended cruise, know the availability of fuel along your route. Practice the One Third Rule; 1/3 to reach the destination, 1/3 to return and 1/3 in reserve.
2. Avoid fueling at night, except under well-lighted conditions.
3. Moor your boat securely to the dock. Know the location of the fire extinguisher in case of emergency.
4. Keep accurate records of your fuel consumption. A fuel log tracking fuel use over time will help determine average consumption.
5. Close all doors, hatches, windows and other compartments.
6. Extinguish cigarettes, pipes, and all other flame producing items.
7. Make sure all power is off, and do not operate any electrical switches.
8. Remove the fuel fill cap using the deck plate key supplied with your boat.

GETTING UNDERWAY

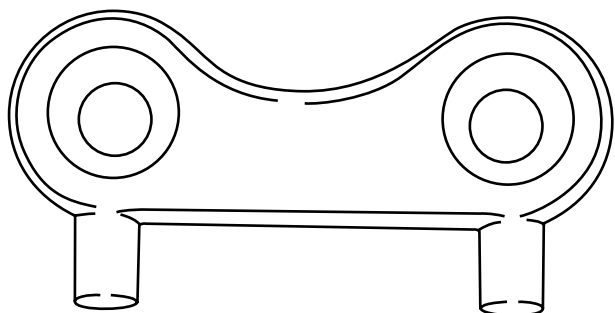

Deck Plate Key
Figure 6-4

9. Insert the hose nozzle and make sure nozzle is in contact with or grounded against fill opening. This will reduce the risk of static spark.

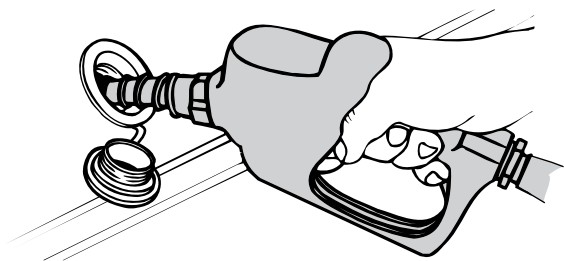

Fueling
Figure 6-5

10. Add fuel in accordance with the propulsion unit operator's manual. Do not overfill, and allow enough room for fuel expansion.

NOTICE

- Each time you refuel, inspect all fuel lines, hoses and connections for leaks and deterioration.
- The Federal Water Pollution Control Act prohibits the discharge of oil or oily waste into the water. Violators can be fined \$5,000.00. We urge you to protect our fragile environment by avoiding any type of discharge, trash or litter into our waterways.

After fueling:

1. Tighten the fuel fill cap using the deck plate key. Wipe up any fuel spillage.
2. Open all windows, hatches, doors and compartments.

3. Check all fuel lines, hoses and connections for leaks and deterioration.
4. Be sure to run the blower for at least four minutes before starting the engines. If you smell gasoline fumes, do not start the engines; continue to run the blower until fumes have dissipated.

PRE-OPERATIONAL CHECKS

⚠ WARNING

Do not operate the boat if any problem is found during this inspection. A problem could lead to an accident during the outing causing severe injury or death. Have any problem attended to by your Formula dealer.

Get into the habit of performing these checks in the same order each time so that it becomes routine.

- Make sure to check all safety items listed in **Safety Checklist**, in this section.
- Check that the bilge drain plug(s) is properly installed.
- Check that all batteries are fully charged and have the proper level.
- Verify the amount of fuel in the fuel tanks.
- Be sure the lights, horn, bilge pumps and other electrical equipment are in operating condition.
- Check that no fuel, oil or water is leaking or has leaked into the bilge compartment.
- Check all hoses and connections for leakage and damage.
- Open all seacocks and check for leaks.
- Check seawater strainers for leaks and accumulation of debris.
- Open raw water drain valves.
- Check that steering system operates properly.
- Make sure the shift lever(s) is in the NEUTRAL position.
- Do not overload your boat.
- Operate the bilge blowers for at least four minutes before starting the engines or generator.

SUN SPORT

BOAT TRIM/LOADING

WARNING

All passengers should be carefully seated while the boat is moving. Do not sit on the bow, bow pulpit, deck or gunwale when the boat is moving.

Know the weight capacity of your boat. Do not overload your boat. Overloading of passengers, personal equipment and supplies could result in an accident, especially in rough waters.

The performance of your boat is dependent on load weight and distribution, drive unit trim and trim tab position. Passengers should distribute themselves to maintain trim. Remember to distribute weight from right to left, and also from front to back.

- Avoid excess weight in the bow or stern.
- Securely stow all extra gear in stowage areas to prevent load shifting. Do not stow gear on top of safety equipment; safety equipment must be quickly accessible.
- In adverse weather, reduce the load in the boat. People/load capacity ratings are based upon normal boating conditions.

Overloading of passengers, personal equipment and supplies could result in an accident, especially in rough waters. Maintain a balanced load at all times.

BOARDING

When boarding the boat, always step in. Do not jump. Avoid stepping on smooth fiberglass or other potentially slippery surfaces. Board one person at a time.

Do not board the boat while carrying gear. Set the gear on the dock, board the boat and then pick up the gear.

Do not use the drive units as a boarding ramp, use the boarding ladder. To prevent injury, make sure the engines are OFF when swimmers, drivers and skiers are boarding.



Section 7 **Operation**

This section describes the basics of starting, running, stopping, steering, trimming and docking your boat. Formula strongly recommends all operators of your boat seek additional training on boat handling and safety. Have all operators become familiar with the handling characteristics and proper steering and control system usage before attempting high-speed operation.

Whenever you are going for an outing, make sure at least one passenger is familiar with the operation and safety aspects of the boat in case of emergency. Show all passengers the location of emergency equipment and explain how to use it. Don't allow passengers to drag their feet or hands in the water, or sit on the bow, bow pulpit, deck, gunwale or transom platform while the engines are running.

STARTING

Your Formula boat may be equipped with a warning system that will sound an alarm if an engine problem develops. The horn may emit a short chirping sound during starting to verify operation. If the warning horn sounds when operating the boat, IMMEDIATELY throttle back to idle speed and shift into NEUTRAL. IMMEDIATELY check the gauges and stop the engines.

CAUTION

Continued operation after the warning alarm has sounded may cause severe engine damage.

⚠ WARNING

Test the carbon monoxide detectors operation before each trip, at least once a week and after the boat has been in storage. Do not tamper with the operation of the carbon monoxide detectors. They are installed for your safety.

Starting Gas Engines

⚠ WARNING

Operate the blower for at least four minutes each time you start the engines. In addition, the blower should be operated continuously when at idle and during slow speed operation. Failure to operate the blower can cause an explosion.

Complete the safety checklist before starting the engines. Please refer to the propulsion unit operator's manual for additional starting procedure information.

⚠ WARNING

- **Attach the ignition safety switches' lanyards to the operator before starting the engines. This will prevent the boat from becoming a runaway if the operator is accidentally thrown away from the helm.**
- **Start the engines with the shift lever(s) in NEUTRAL. Your boat is equipped with a neutral safety switch which will not allow engines to be started unless the shift lever(s) is in the NEUTRAL position.**

SUN SPORT

1. Attach the ignition safety switch clips to the switches; connect the hooks to a secure place on the operator.
2. Move shift lever(s) to the NEUTRAL position.
3. Move throttle lever(s) to the IDLE position.
4. Turn the ignition key of one engine to START position. Release the key immediately after the engine starts. If the engines fail to start, refer to the propulsion unit operator's manual for additional information.

CAUTION

Failure to release the ignition key after the engine starts may damage the engine's starter motor.

5. Operate the engine at approximately 1000 RPM. Check the oil pressure gauge. If the oil pressure is not within specified range, stop the engine immediately. Contact your Formula dealer to service the engine.
6. Repeat starting procedure for the second engine. The second engine may be difficult to hear when it starts due to the noise of the first engine. Observe the tachometer of the second engine. When the RPMs increase, release the ignition key immediately.
7. Allow the engines to warm up. Check the water temperature gauges to be sure water temperature remains within the specified range. If the temperature gauge reads abnormally high, stop the engine immediately. Check the drive unit's water inlets for blockage. If the inlets are open, contact your Formula dealer to service the engine.

Starting Diesel Engines

⚠ WARNING

Operate the blower for at least four minutes each time you start the engines. In addition, the blower should be operated continuously when at idle and during slow speed operation. Failure to operate the blower can cause an explosion.

Complete the safety checklist before starting the engines. Please refer to the propulsion unit operator's manual for additional starting procedure information.

⚠ WARNING

- **Attach the ignition safety switches' lanyards to the operator before starting the engines. This will prevent the boat from becoming a runaway if the operator is accidentally thrown away from the helm.**
- **Start the engines with the shift lever(s) in NEUTRAL. Your boat is equipped with a neutral safety switch which will not allow engines to be started unless the shift lever(s) is in the NEUTRAL position.**

1. Attach the ignition safety switch clips to the switches; connect the hooks to a secure place on the operator.
2. Move shift lever(s) to the NEUTRAL position.
3. Move the throttle lever of the engine to be started to approximately one-half throttle position.
4. Turn the ignition key of one engine to START position. Release the key immediately after the engine starts. If the engines fail to start, refer to the engine operator's manual for additional information.

CAUTION

Failure to release the ignition key after the engine starts may damage the engine's starter motor.

5. Operate the engine at approximately 1400 RPM. Check the oil pressure gauge. If the oil pressure does not rise to specified range in 15 seconds, stop the engine immediately. Contact your Formula dealer to service the engine.
6. Repeat starting procedure for the second engine. The second engine may be difficult to hear when it starts due to the noise of the first engine. Observe the tachometer of the second engine. When the RPMs increase, release the ignition key immediately.
7. Allow the engines to warm up. Check the water temperature gauges to be sure water temperature remains within the specified range. If the temperature gauge reads abnormally high, stop the engine immediately. Check the drive unit's water inlets for blockage. If the inlets are open, contact your Formula dealer to service the engine.

SHIFTING

CAUTION

- Go slowly in REVERSE to avoid taking water in over the transom. You can swamp the boat by taking on too much water.
- Do not shift too quickly from FORWARD to REVERSE. Damage to the engines may result. When shifting from FORWARD to REVERSE, pause in NEUTRAL until the engines are at idle speed and the boat has slowed.

Follow these guidelines when shifting your boat:

- Keep the control area clean and clear of obstructions.
- Pause in NEUTRAL before shifting from FORWARD to REVERSE, or REVERSE to FORWARD.
- Avoid shifting into REVERSE while the boat is traveling forward at speed.

STEERING

⚠ WARNING

The boat's steering system is not self-centering. Propeller torque, trim setting, water condition and boat speed affects the steering. Constant attention to the steering system is required for safe operation.

The steering system must be working correctly and properly maintained. Be sure to:

- Keep mooring lines, tow lines and other obstructions clear of the steering system.
- Keep the steering system's moving parts clean and lubricated.
- Regularly inspect the steering system for kinks, damage and corrosion.

RUNNING

Make sure the transom door remains closed when operating your boat. Observe the tachometers and maintain equal RPMs on both engines.

Exhaust Diverter System (optional on select stern drives)—Some stern drive Formulas have an optional exhaust diverter system which switches the output of the engines' exhaust either to thru-hull exhaust pipes (above water) or down through the propeller hub (below water). The exhaust diverter switch determines the routing of the engine exhaust.

In the ON position, engine exhaust is routed through the hull pipes. This position produces the most engine power, but is not acceptable near shore or on inland lakes and rivers.

In the OFF position, engine exhaust is routed down through the hub of the propeller. This position releases the exhaust underwater providing a quieter engine sound.

Be sure to check local regulations regarding noise restrictions before operating this system.

CAUTION

To avoid damage to the exhaust system, do not switch the exhaust above 3,000 RPM.

STOPPING

Stopping (checking headway) is a technique that must be developed. Reverse thrust of the engines is used to slow and stop the boat. The boat's momentum will vary according to load, speed and water condition. Slow the engine speed to an idle, shift to NEUTRAL and pause, before shifting to REVERSE. Refer to your propulsion unit operator's manual for additional information concerning shifting.

Stopping Gas Engine

⚠ WARNING

Do not use the ignition safety switch and lanyard for normal stopping of the engines. Doing so will impair your ability to restart the engines quickly or may create a hazardous swamping condition.

1. Slowly bring the throttle lever(s) to the IDLE position.
2. Move the shift lever(s) to NEUTRAL.
3. After operating at high speeds, allow a 2-3 minute engine cool-down period at low idle.
4. Turn the ignition keys to the OFF position.

SUN SPORT

NOTICE

If any problems are encountered during the outing, have your boat inspected by your Formula dealer and request any necessary repairs before your next outing.

Stopping Diesel Engines

⚠ WARNING

Do not use the ignition safety switch and lanyard for normal stopping of the engines. Doing so will impair your ability to restart the engines quickly or may create a hazardous swamping condition.

1. Slowly bring the throttle lever(s) to the IDLE position.
2. Move the shift lever(s) to NEUTRAL.
3. Move the throttle lever(s) forward until engine speed is approximately 1400 RPM. Refer to propulsion unit operator's manual for cool down procedure.
4. After cooling the engines, move the throttle lever(s) back to the IDLE position.
5. Turn the ignition keys to the OFF position.

Depending on the engine package, an additional step may be necessary when stopping the engine. You may have to turn the key back past OFF or you may have to press a button. With either method, be sure to turn the key to the OFF position before leaving the helm. Refer to your propulsion unit operator's manual for additional information on stopping the engine.

NOTICE

If any problems are encountered during the outing, have your boat inspected by your Formula dealer and request any necessary repairs before your next outing.

ENGINE FLUSHING

Even for those engines equipped with closed-water-cooling, flushing with fresh water is recommended after each use in salty, polluted or brackish water to minimize the formation of deposits that can clog engine cooling passages.

To facilitate engine flushing, fresh water flush kits are available as a factory-installed option from both Formula and the various engine manufacturers. The following descriptions and instructions pertain only to Formula-installed fresh water flush systems.

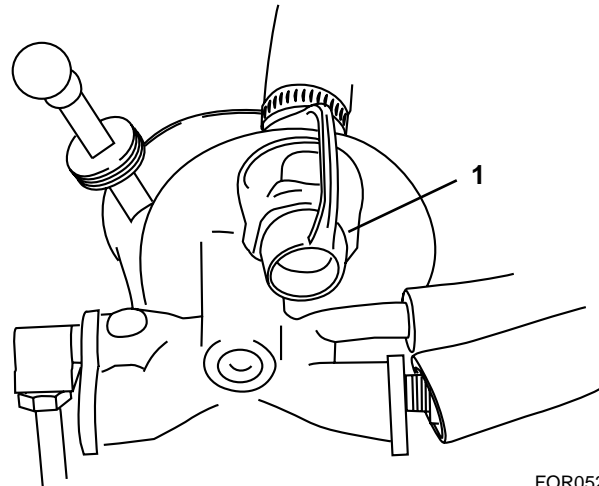

FOR052

1. Fresh Water Flushing Port

**Fresh Water Flushing Port
Figure 7-1**

An adapter is included with your boat to connect a garden hose to the port.

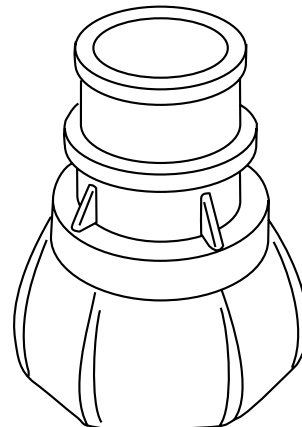

**Flushing Adapter
Figure 7-2**

FOR053

To Flush an Engine:

NOTICE

Your Formula boat must be out of the water and on a trailer or lift when the engine is flushed.

1. Remove the cap from the flushing port.
2. Connect a garden hose to the adapter. Snap the adapter into the port. Do not turn on the water until the engine is started.
3. Start the engine to be flushed. Immediately turn ON the water. Run the engine at idle speed only for 5 to 10 minutes.
4. Turn OFF the engine and the water. Depress the tab on the adapter to remove it. Install the cap on the flushing port.

OPERATING AT HIGH SPEED

WARNING

- **Maneuverability above 50 MPH is limited. Sudden turns may cause loss of control.**
- **Your Formula boat is not designed for wake jumping. When crossing another boat's wake, throttle back to prevent your boat from leaving the water. Wake jumping is very dangerous. It is possible for the boat to re-enter the water on its side, transom or bow. You and your passengers could suffer serious injury. Also, damage to the boat could take place causing a hazardous condition.**

When operating any boat at high speed, exercise a great deal of caution. This is particularly true during turns. Gradual turns can be completed at high speed by a competent driver, but, it must be emphasized that sudden turns at any speed and particularly at high speed can be especially dangerous. It is possible to throw passengers from their seats and even from the boat if caution is not exercised. Remember, common sense is the rule for safe boating.

We recommend you should have ten hours of experience with the boat before any full throttle operation. Do not operate your boat until you are completely experienced with its handling characteristics. The following are some guidelines for performance operation.

- Keep the bottom of the hull clean and free of barnacles and other growth. Growth on the hull can slow the boat down considerably.
- Prepare the boat. Be sure all gear is properly stowed and compartments are latched.
- Weight distribution affects performance. Keep weight in the boat to a minimum and evenly distributed.
- The propellers should be of the proper pitch to turn the recommended RPM rating for the engine with an average boat load. Refer to your propulsion unit operator's manual for additional information.
- Watch the tachometer. Keep the engines within the full throttle operating range. Refer to the propulsion unit operator's manual for full throttle operating range.

WARNING

Keep one hand on the steering wheel and the other on the throttle levers at all times. If the boat begins to operate in an unsafe way, pull back on the throttle levers. Trim the drive units IN at the same time. Failure to maintain control could result in severe injury or death.

High-speed operation on smooth water is very stable, but quick reactions and adjustments are needed to maintain control. Know your limits and stay within them. Keep one hand on the steering wheel and the other on the throttle levers; constant adjustments are necessary for rapidly changing conditions. Small inputs of throttle and steering movement are exaggerated at high speeds. Keep watch well ahead so you have enough time to react.

SUN SPORT

PROPELLER EFFECT

The effects of unequal propeller thrust, wind and current must also be kept in mind. While wind and current may not always be present, an experienced boater will use them to his advantage.

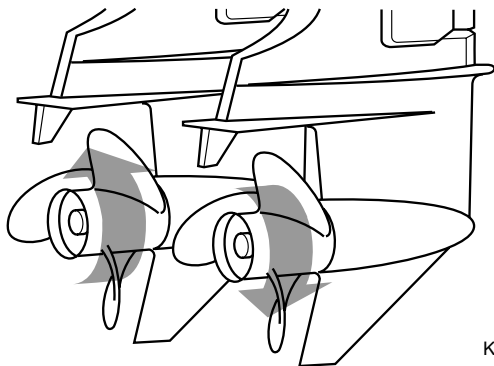

KC-2340

Propeller Effect
Figure 7-3

Twin-engine craft with counter-rotating drive units operate with less propeller-torque-induced drifting as compared to the same craft with like-rotating drives or, for that matter, single-engine boats with one propeller. This helps maintain an even keel, as the torque of the counter-rotating propellers is effectively a "wash."

MANEUVERING TECHNIQUES

Steering response depends on drive unit position, trim tab position, motion and throttle.

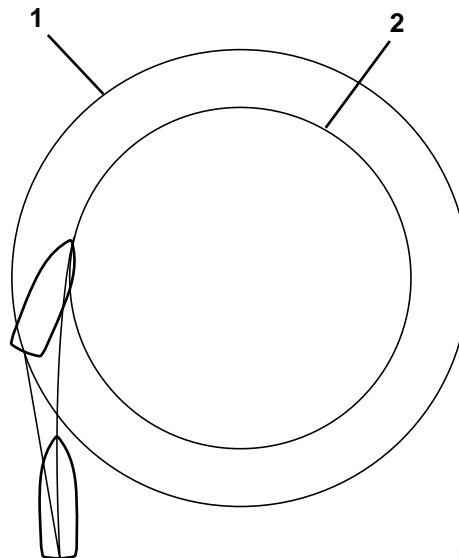

FOR150

1. Stern Circle
2. Bow Circle

Maneuvering
Figure 7-4

Wandering is a characteristic of all deep vee hulls at slow speed. There is no cure for wandering, however, a very basic operational technique can be applied which will minimize this characteristic. If the steering wheel is moved back and forth to compensate for wandering, invariably, the situation will be magnified. If the steering wheel remains in a centered position, the boat will wander back and forth slightly, however, the overall course of the boat will be a straight one.

When operating your Formula boat at low speeds, use propeller thrust to maneuver the boat, do not just turn the drive units. This enables you to maneuver in a smaller area and have more control of the boat. This technique is a combination of propeller direction, engine thrust and steering wheel maneuvers.

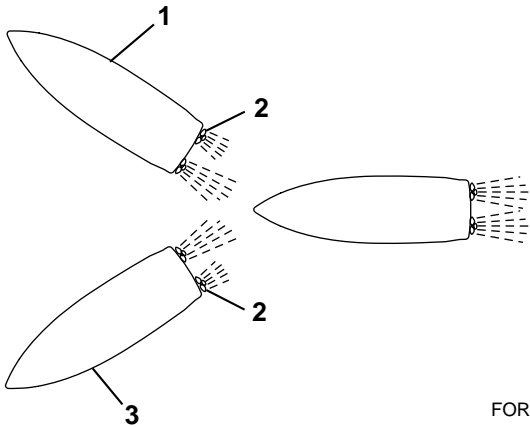

1. Starboard Turn
2. Slower Propeller
3. Port Turn

Slow Speed Maneuvering
Figure 7-5

When making tight maneuvers, it is important to understand the effects of turning. Since both thrust and steering are at the stern of the boat, the stern will push away from the direction of the turn. The bow follows a smaller turning circle than the stern.

To Make Sharp and Close Quarter Turns:

1. Slow engine speed to an idle, shift to NEUTRAL and pause, then shift to REVERSE. This practice will help prevent damage to your drive units.
2. Reverse the direction of the propeller on the side you want to turn. For example, if you want to turn starboard, shift the starboard engine into REVERSE. The forward speed of the port engine, along with the reverse rotation of the starboard propeller, will pivot your boat into a starboard turn.
3. Practice using the shift lever(s) to control the boat. Try maneuvers in open water before attempting them near docks or other boats.
4. Use a quick "burst" of your shifters to control the boat. Keep in mind that once the boat starts to move, momentum will carry through.

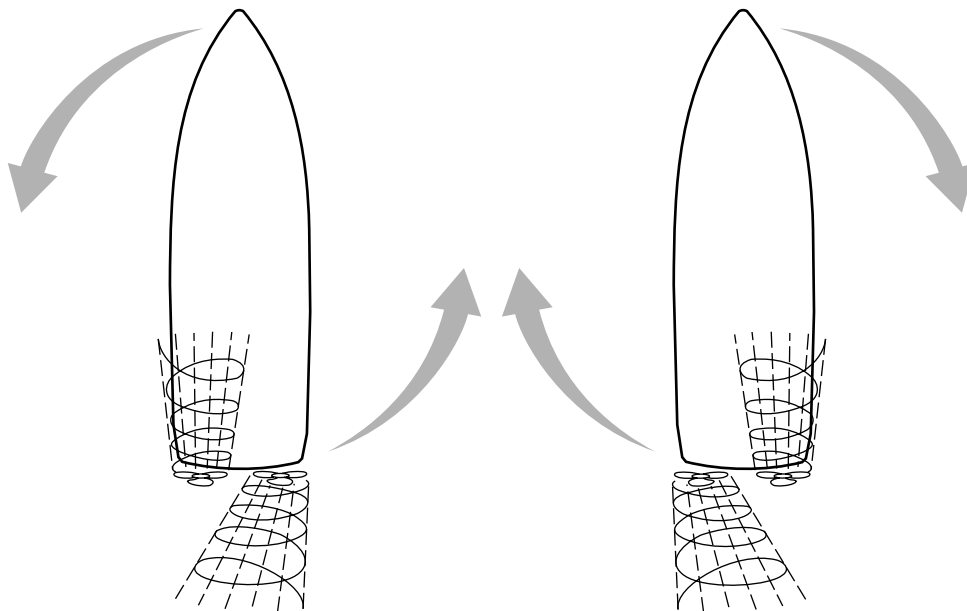

Close Quarter Turns
Figure 7-6

It is best to learn maneuvering skills in open water away from traffic. Adequate practice is the only way to develop your boating skills.

SUN SPORT

BOATING AT NIGHT

NOTICE

Operate the boat between sunset and sunrise using your navigational lights. Navigational lights are legally required to indicate direction and right-of-way at night.

Boats operating between sunset and sunrise (hours vary by state) must use navigation lights. Nighttime operation, especially during bad weather or fog, can be dangerous. All Rules of the Road apply at night; it is best to slow down and stay clear of all boats, regardless of who has right-of-way.

Protect your night vision by avoiding bright lights. Have a passenger, if possible, help keep watch for other boats, water hazards, and aids to navigation.

The size, speed, and direction of the other vessels are determined at night from the running lights. A green light indicates the starboard side of the boat, and a red light indicates the port side. Generally, if you see a green light, you have the right-of-way; if you see a red light, give-way to that vessel.

Navigational Lights

You must use your navigational lights (running lights) when operating your Formula boat between sunset and sunrise, and when day time visibility is limited. Also, check with the local authorities before operating your boat for other requirements concerning the use of navigational lights.

The navigational lights are identified by a red light on the port side of the vessel, and a green light on the starboard side.

Anchor Light

All boats at anchor must display a proper white anchor light. The anchor light (all around light) is the white light located on top of the radar tower or extended on a pole from a position on the deck for boats without an arch. The anchor light must be visible 360 degrees and remain on anytime the boat is moored.

Docking lights are to be used for docking only. It is illegal to use your docking lights while cruising.

SPECIAL OPERATING CONDITIONS

Using your boat in different environments requires special operating considerations.

Salt Water

During long periods of mooring, if possible, tilt the propulsion units drives out of the water—except in freezing temperatures.

Fresh water flushing of the engines is recommended after operating in salt, polluted or brackish water. On non-closed water cooling engines, Formula may provide a fresh water flushing port. Refer to **Engine Flushing**, in this section, for additional flushing information.

Refer to the propulsion unit operator's manual for that manufacturer's salt water operating recommendations.

Freezing Temperatures

When boating in temperatures below freezing, keep the propulsion unit's drives tilted down (submerged) at all times. This will prevent damage from freezing.

Upon removing your Formula boat from the water, leave the drive units in the vertical position until the cooling system has drained. Refer to your propulsion unit operator's manual for additional information.

Use caution when handling clear isinglass on the Bimini enclosure in low temperatures to prevent damage from cracking.

HOLDING POSITION

Wind and/or current will affect the boat's speed, course and time to reach your destination. When traveling to your destination, wind and/or current will cause the boat to deviate from the intended course. The amount of difference between the intended course and the course the boat must travel to reach your destination is called leeway. The wind or current pushes sideways on the boat causing it to travel at an angle to the intended course. The speed of the boat determines the amount of leeway between the intended course and the traveled course.

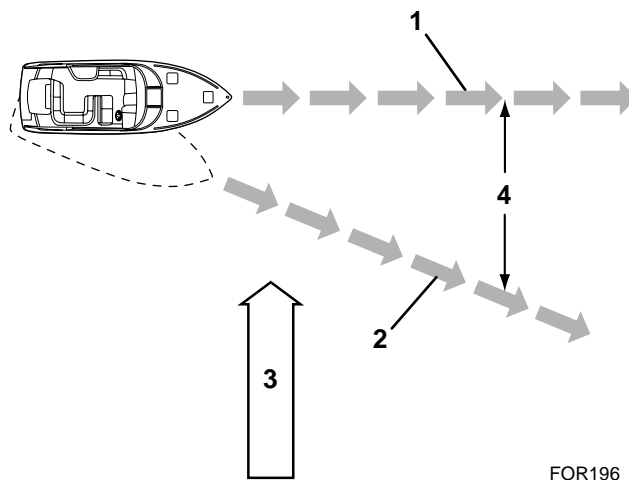

FOR196

1. Intended Course
2. Traveled Course
3. Wind/Current
4. Leeway

Effects of Wind/Current
Figure 7-7

TRIMMING-DRIVE UNITS AND TRIM TABS

Boat trim while on plane is influenced by load distribution, drive unit trim and trim tab trim.

Determining the best boat trim while underway takes time. It is best to experiment with different drive and tab trim combinations while taking note of the condition.

Drive Unit

Trim angle is the angular relationship between the drive unit and the transom of the boat. Boat trim while underway greatly affects the performance and efficiency of your boat. For best results, the boat should be on plane and trimmed to reduce the amount of the boat's hull in the water (known as wetted surface). With less boat in the water, both speed and fuel economy increase. Continuous trim adjustment is required when operating your boat to maintain maximum performance and efficiency.

If the drive units are trimmed in too far (closer to the boat bottom), speed drops, fuel economy decreases and the boat may not handle correctly. However, it does provide better acceleration from a stand still; and because it forces the bow down, visibility is improved. If the drive units are trimmed out too far (away from the boat bottom), steering torque may increase, the boat may be difficult to get on plane, and may bounce.

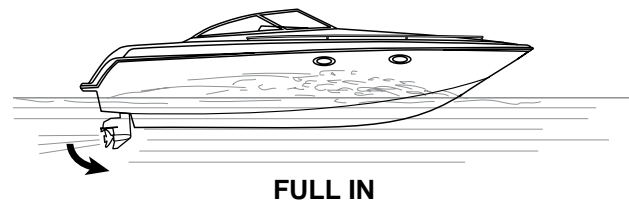

FOR223

Drive Angle Trim
Figure 7-8

To use power trim effectively, start with the drive units trimmed in. As the boat planes, increase the angle out. Experience is the best teacher for understanding proper drive trim.

SUN SPORT

Trim Tabs

The trim tabs are a separate system in themselves and are not to be used in lieu of the drive unit power trim system. Water is deflected and redirected as the trim tabs are raised and lowered. This change in the water flow creates upward pressure under the tabs and raises the stern. When the stern raises, the bow is lowered. Likewise, lowering the port tab will cause the port stern to raise, making the starboard bow lower.

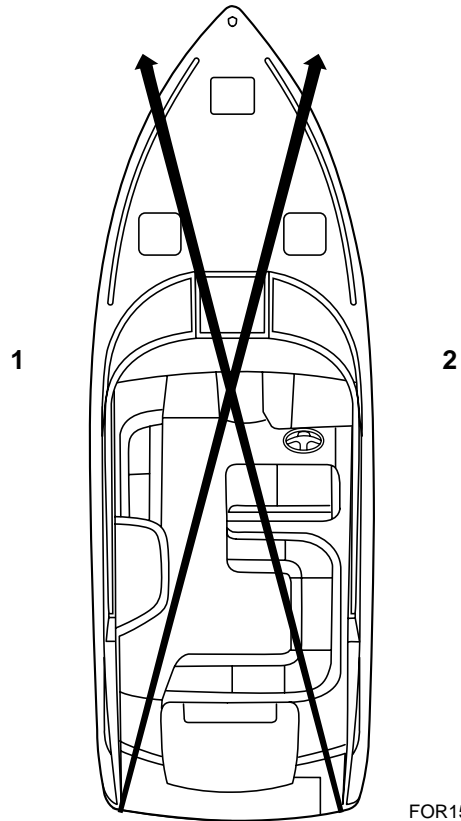

FOR153

1. Port Trim Tab Lowered
 - Port Stern Rises
 - Starboard Bow Lowers
2. Starboard Trim Tab Lowered
 - Starboard Stern Rises
 - Port Bow Lowers

Trim Tabs
Figure 7-9

OPERATION

Using trim tabs in conjunction with the drive trim will compensate for uneven weight distribution, listing, water conditions and other factors that

cause inefficient operation. Remember that trim tabs are trimming the hull while the power trim is trimming the drive unit.

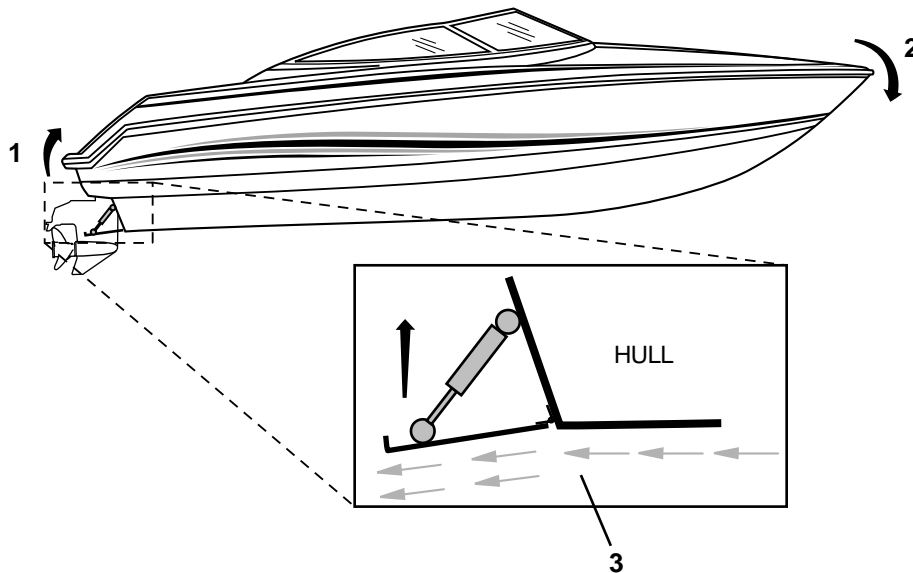

FOR102

1. Stern Rises
2. Bow Lowers
3. Water Is Redirected Creating Upward Force At Stern

Trim Tab Operation
Figure 7-10

SUN SPORT

To adjust boat trim while underway:

1. Before accelerating, make sure both trim tabs are fully raised.
2. Adjust the trim tabs to achieve a planing attitude.
3. Use the drive trim to position the propeller path parallel to the water flow.
4. Readjust the trim tabs to fine tune attitude. Operate only one tab at a time and in small increments. As the tab takes effect, you will notice it causes the boat to veer off course slightly. Correct for this as it happens.
5. To prevent the boat from listing, do not have one tab further down than the other tab.

⚠ WARNING

Improper use of the trim tabs at high speeds can cause an accident or injury.

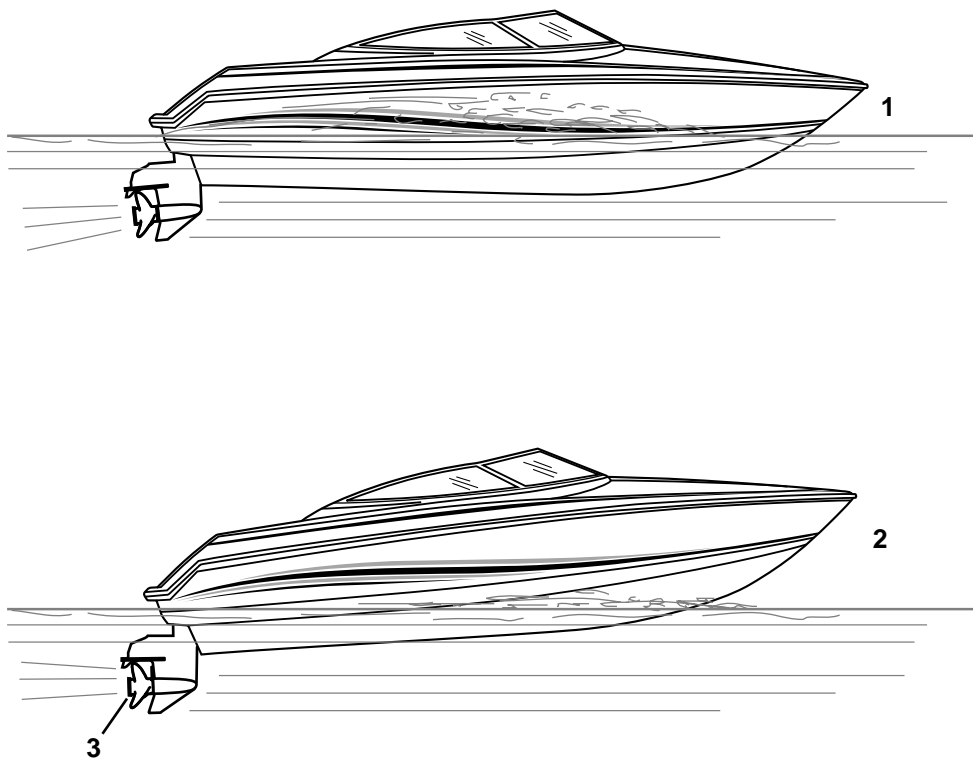

FOR155

1. Untrimmed
2. Planing Altitude
3. Propeller Parallel To Water Flow

**Trim Tab/Power Trim Operation
Figure 7-11**

ANCHORING AND SEA ANCHORS

Windlass

The windlass is operated from the driver's helm. The windlass system can also be operated manually. A manual hand crank is located in the anchor locker.

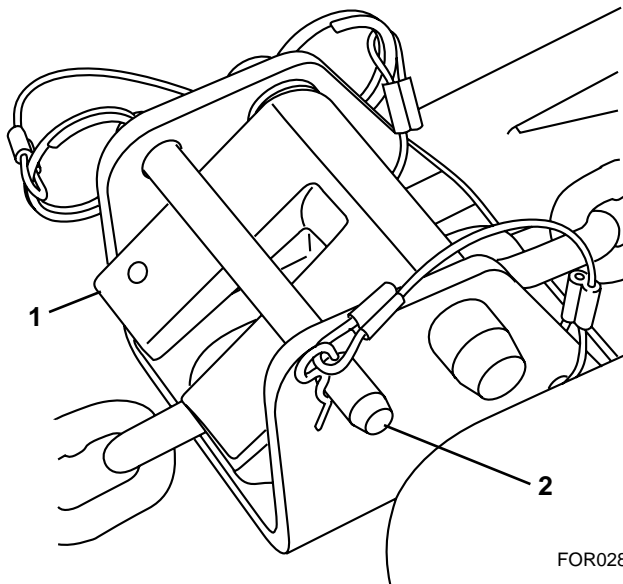

FOR028

1. Chain Stop
2. Lock Pin

Windlass Lock Pin Installed
Figure 7-12

The chain stop (**Fig. 7-12, 1**) is used to immobilize the anchor in the stowed position and a lock pin (**Fig. 7-12, 2**) secures the chain stop. The lock pin must be installed at all times when the windlass is not in use. Refer to the operator's manual supplied with the windlass system for proper operation of the windlass in the electric and manual modes.

⚠ WARNING

The lock pin must be installed in the anchor bracket when the windlass is not in use. Do not operate your boat without the lock pin installed.

A 100-amp circuit breaker protects the Windlass electrical circuit. Refer to **Specifications**, in **Section 3**, for location of the circuit breaker.

Use caution when anchoring. Look for signs of underwater pipes or cables. With the engines off, you have no control of the boat. Water and wind conditions will affect an anchored boat. Be sure the anchor will hold before leaving the boat.

⚠ WARNING

- Keep hands, feet, loose clothing and hair well clear of the winch and chain during operation.
- Be sure you have a clear view of the winch when operating it.
- Run the boat's engines while raising or lowering the anchor. Not only is this a safety precaution, it also prevents draining of the batteries.
- Do not use the winch as a bollard. When anchored, secure the anchor line directly to a bollard or deck cleat.
- Secure the anchor with a rope or fastener pin when operating the boat at high speed or in heavy weather.

Lowering—Bring the boat to a stop with the bow facing into the wind or current. Lower the anchor. Press the toggle switch down to pay out sufficient chain to set the anchor.

Setting—When the anchor hits bottom, slowly back up the boat, keeping tension on the chain. The anchor line should be five to seven times the depth of the water.

Weighing—To weigh (retrieve) the anchor, start the engines and slowly move forward. Press the windlass switch up while taking in anchor line as you go. Carefully retrieve the last 36 inches of chain, then seat the anchor in the bow fitting.

Conventional Anchor

⚠ WARNING

Anchor from the bow, not from the stern. A strong current can pull a boat, anchored by the stern, underwater and keep it there.

SUN SPORT

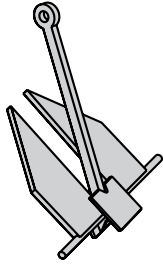

KC-1571

Danforth Anchor
Figure 7-13

There are many types of anchors available on the market. The choice of one anchor over another depends on many factors. An anchor will usually hold best in a mixture of mud and clay or in hard sand. A Danforth anchor is recommended for general boating. For more information on anchors, contact your Formula dealer.

Lowering—Make sure the line is tied to the anchor and tie the other end to the forward cleat or bow eye.

Head the boat into the wind or current over the spot where you want to lower the anchor. Spot the boat before lowering the anchor.

Setting—When the anchor hits bottom, slowly back up the boat, keeping tension on the line. Let out an anchor line that is 4 to 6 times the depth of the water. For example, if you are in 10 feet of water, let out 40 to 60 feet of line.

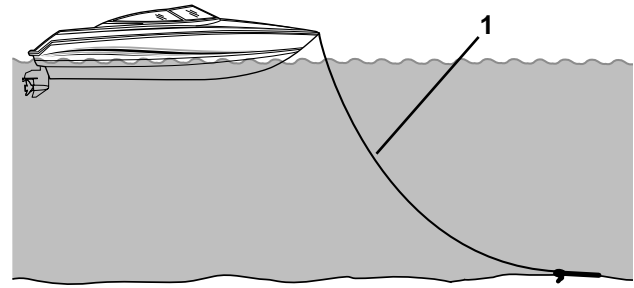

FOR148

1. Length of Line — 4 to 6 Times Depth of Water

Anchoring
Figure 7-14

Occasionally check your position against the shoreline. If the anchor is dragging and you are drifting, reset the anchor.

Weighing—Start the engine(s) and move forward until the anchor line is straight up and down. Pull hard to lift the anchor from the bottom material.

If the anchor is caught on the bottom, attach a line to the bow cleat so that it is taut. The up and down motion of the bow from wave action may lift the anchor from the bottom. If the anchor remains caught, let out a few more feet of line and attach it to the bow cleat. Slowly maneuver the boat around the anchor until the anchor pulls loose. Be sure to keep the line tight during this procedure.

Sea Anchor

A sea anchor is used to hold the boat's bow into the wind and waves in heavy seas when the boat has lost its power. This will reduce the drifting of the boat.

A sea anchor has a general shape of a parachute. A sea anchor construction can be like a parachute canopy or a lattice web design. A rope attaches the sea anchor to the boat. Floats with trip lines allow the sea anchor to be pulled back into the boat.

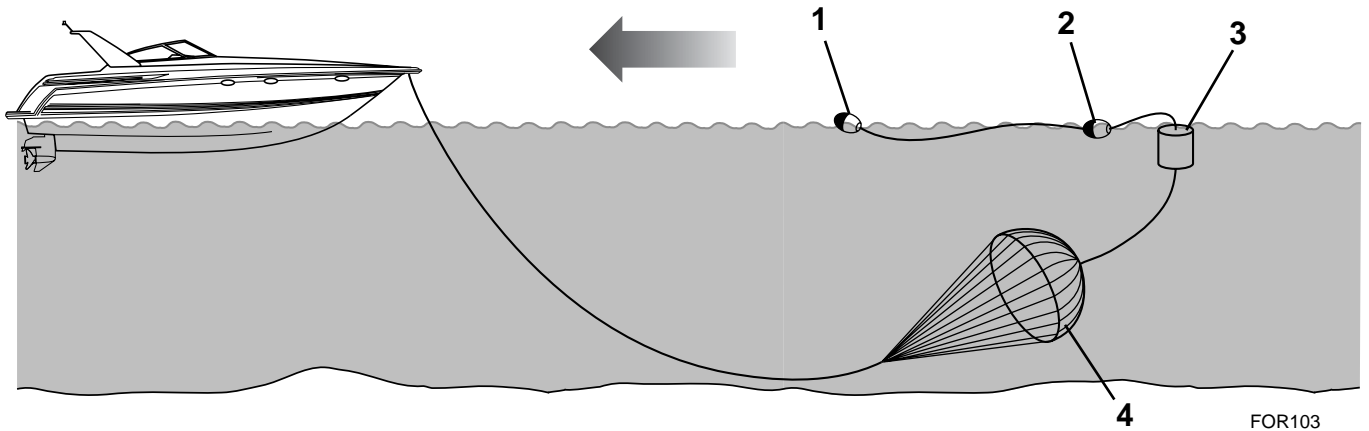

1. Recovery Float
2. Float

3. Stowage bag
4. Sea Anchor

Sea Anchor
Figure 7-15

TOWING AND BEING TOWED

If seas are rough, it may not be easy to extend the tow line from one boat to another. In these cases, use a light throwing line with a weight on one end and with the heavier towing line secured to it.

Do not attempt to tow a much larger or grounded vessel. Because of the tremendous stress caused by towing, use a tow line that is rated at least four

times the gross weight of the boat being towed. Tow ropes must be in good condition, free of any cuts or abrasions.

Attach the tow line to the bow eye on the disabled boat. Attach the opposite end of the bridle only to the stern eyes of the tow boat. Wrap the bridle with chafing gear where it rubs against the boat. Leave at least two boat lengths between the boats for adequate movement.

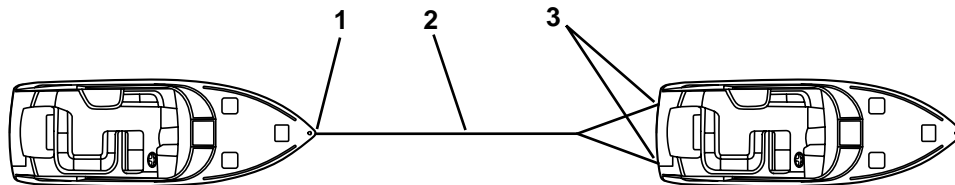

1. Bow Eye
2. Tow Line
3. Stern Eyes

Towing
Figure 7-16

WARNING

When towing, use only the bow and stern eyes; do not use cleats, handrails, etc. Do not allow anyone to be in line with the tow rope. If the rope should break or pull free, a dangerous recoil could occur resulting in severe injury or death to anyone in its path.

Adjust the tow line to match wave action. Keep the boats on the crest or in the trough of the waves at the same time. In protected, calm waters, shorten the line for better handling. Tow at moderate speed, allowing for adverse wind and wave conditions. Have the operator of the towed boat steer with you, if possible.

If you need a tow, or wish to tow another boat, use great care. The boat structure can be damaged by excessive pulling strain. You should offer help to a boat in trouble. However, towing a capsized, grounded or hull damaged boat is dangerous. Give assistance to the occupants; then call the proper authorities.

HEAVY WEATHER

Getting caught in severe weather is hazardous. Check with local weather stations, the USCG, or Weather Service Broadcasts for the latest conditions. It is recommended to check the weather, sea and wind conditions not only before you leave, but, periodically while you are boating.

A change in wave height, wind direction and speed indicates deteriorating weather. Take common sense precautions if you are forced to operate your boat in stormy conditions:

- Wear PFDs.
- Stow gear below deck and batten down equipment on deck.
- Reduce speed and head for a safe place that you can easily reach.
- If you lose power, keep the boat headed into the waves by using the anchor.

Learn the storm signals.

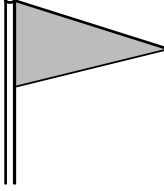
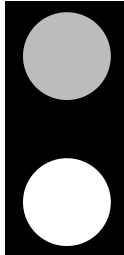
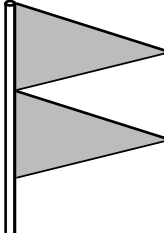
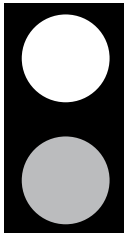
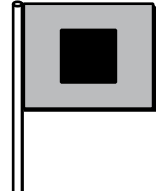
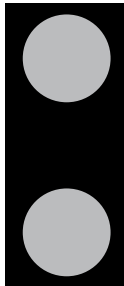
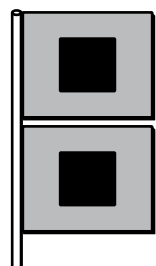
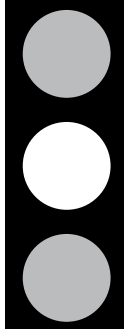
DAYTIME WARNING	DESCRIPTION	NIGHTTIME WARNING
	Small Craft Advisory - Winds greater than 18 knots, sustained for two hours or more or hazardous wave conditions. Following a storm, hazardous wave conditions can persist long after the high winds have subsided.	
	Gale Warning - Sustained winds (2 or more hours), of 34-47 knots.	
	Storm Warning - Sustained winds of 48 knots or greater.	
	Hurricane Warning - Forecast winds of 64 knots and above. Displayed only in connection with a hurricane.	

 Actual Signal in red

KC-0371

Storm Signals
Figure 7-17

It is best to avoid operating your boat in foggy weather. When fog sets in, take bearings and log courses and speeds. You are required to emit a

five-second blast from your horn or whistle once every minute. Additionally, have passengers wear PFDs and watch for oncoming vessels.

SUN SPORT

SWIMMING AND DIVING

Larger boats produce a wake too big for skiers. Only boats equipped with a ski-tow eye should be

used to pull water skiers. It is unlikely that anyone would ski behind your Formula boat, but you should be familiar with water sport safety and hand signals.



Water Sport Hand Signals
Figure 7-18

NOTICE

It is unlawful to participate in water sports while under the influence of alcohol or other drugs.

When participating in water sports, be safe and courteous and follow these guidelines:

- Be considerate to fishermen and others you share the water with.
- Do not perform water sports in congested areas.
- Stay away from navigation markers.
- Stay away from other boats and water sports participants.
- Return immediately to a fallen water sport participant.
- Regularly inspect water sport equipment to ensure it is safe.
- Do not use any fuel burning appliances with a transom exhaust port when swimming from the stern swim platform.

⚠ WARNING

- Water sport participants must wear a USCG approved flotation device. A Type III water ski vest is an approved and practical PFD.
- Keep at least 100 ft away from all other objects.
- When water sporting, have an experienced driver and aft facing observer in the boat.
- Do not water sport in shallow water or at night.
- Do not jump from a moving boat.
- Keep a downed water sporter in sight.
- Turn the engines OFF before you get close to someone in the water.

DOCKING

Approach a dock slowly and use caution. Plan your maneuvers ahead of time. Allow wind and current movement to help maneuver your boat.

⚠ WARNING

Do not use your hands, arms or another part of your body to attempt to keep the boat from hitting the dock. The boat could push against the dock, causing severe injury.

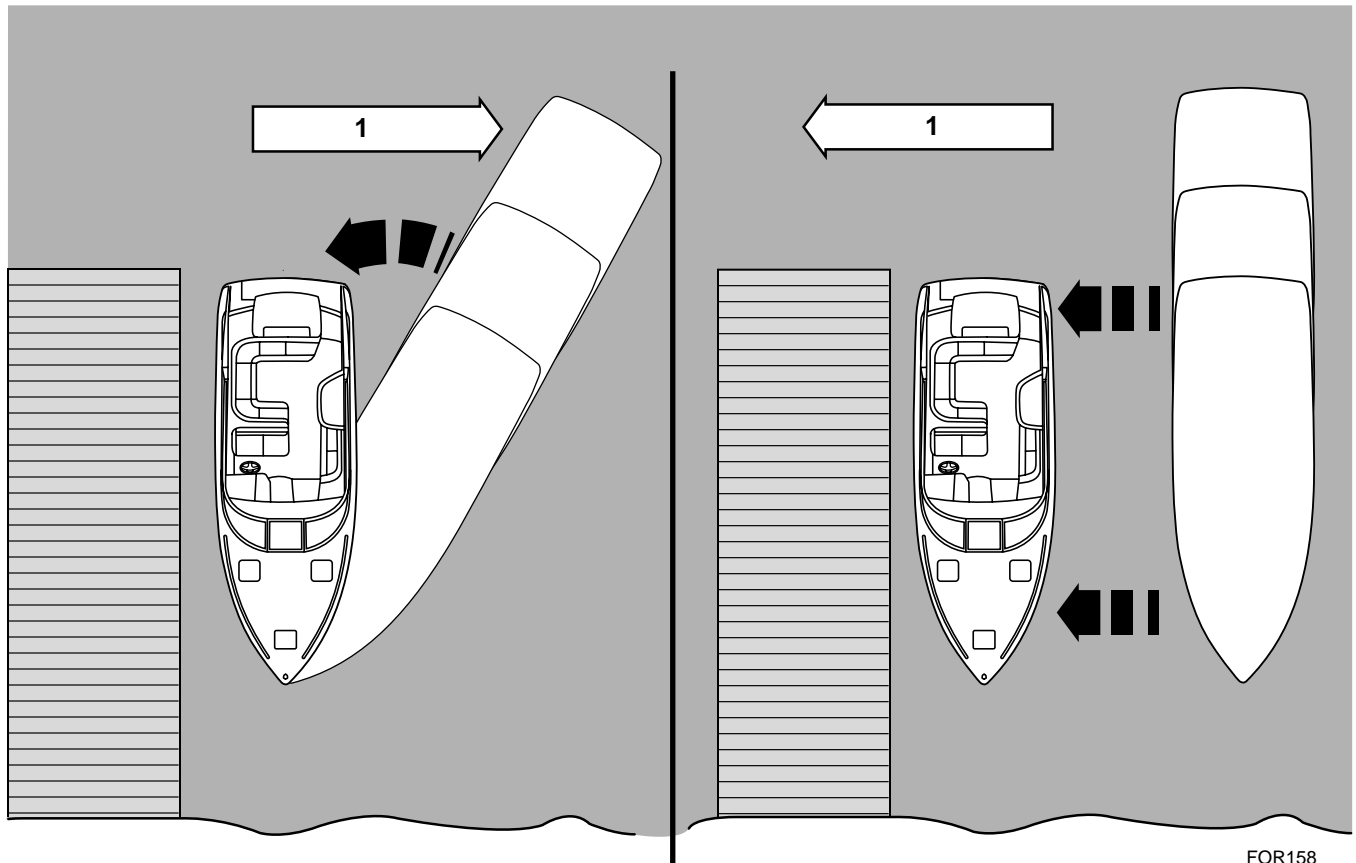

FOR158

1. Wind or Current

Docking
Figure 7-19

Follow these guidelines when docking:

- Come to a stop a short distance from the dock, then proceed slowly.
- Have your fenders, mooring lines and the crew ready.
- Observe how the wind and current are moving your boat. Approach the dock with the boat pointed into the wind, if possible. If the wind or current is pushing you away from the dock, use a sharper angle of approach. If you must approach the dock downwind or

down current, use a slow speed and shallow angle. Be ready to reverse to stop and maintain position.

- If there is no wind or current, approach the dock at a 10° to 20° angle.
- If possible, throw a line to a person on the dock and have that person secure a bow line. If no one is on the dock, maneuver as close as you can, then secure any line to a piling or dock cleat.
- With the bow secure, swing the stern in using engine thrust, or pull it in with a boat hook.

SUN SPORT

Approaching a Slip

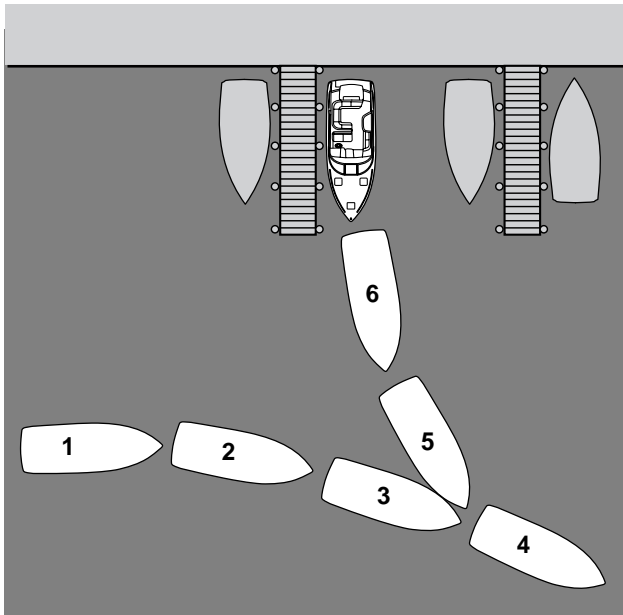

FOR159

Approaching a Slip
Figure 7-20

This maneuver is similar to backing an automobile into a garage or parking space. When approaching a slip:

- Have fenders, mooring lines and the crew ready.
- Turn the boat's stern toward the slip.
- Shift to REVERSE.
- Maneuver slowly into the slip then shift to forward. Use your steering wheel and throttles to align the boat with the slip.
- Once aligned, shift to reverse and continue to back in slowly. Shift to FORWARD when completely in to stop the movement of the boat.
- Shift to NEUTRAL, secure the mooring lines and stop the engines.

Approaching a Mooring

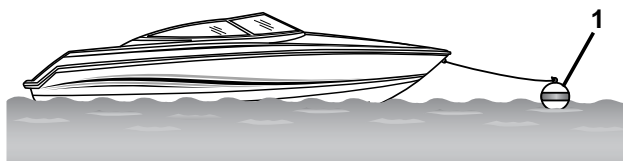

FOR160

1. Mooring Buoy

Mooring to a Mooring Buoy
Figure 7-21

The only buoys you are permitted to moor to are mooring buoys. Mooring to a navigation buoy or other navigational aids or regulatory marker is illegal.

Approach a mooring buoy by heading into the wind or current. Observe the direction of other boats that already lie at mooring buoys. Since they are heading into the wind or current, approach your buoy at the same heading.

- When you think you can move enough forward without using your engines, shift to NEUTRAL.
- Have a crew member positioned on the bow with a hook to retrieve the mooring line. At that point, the crew member should be guiding your maneuvers toward the buoy.
- Turn OFF the engines after the mooring line is attached to the boat.

MOORING LINES

Only use good quality double-braided nylon line. Use chafing protectors on the lines to protect your boat's finish. Only use the cleats, bow eye and stern eyes to secure your boat. Do not use the hand rails or windshield. If possible, tie up your boat with the bow toward the waves and leave a little slack in the lines to allow for some wave movement or tidal action.

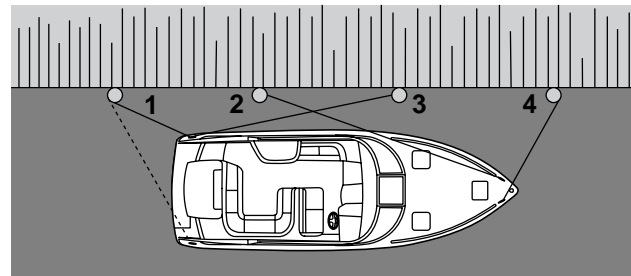

FOR161

1. Stern Line
2. Forward Quarter Spring
3. After Bow Spring
4. Bow Line

Mooring Lines
Figure 7-22

Use your dock lines to help maneuver the boat near the pier and to secure it. Use the following information to secure your boat to a pile or dock cleat:

The bow line is fastened to the bow cleat and is pulled forward at about a 45° angle. This line keeps the boat from moving astern.

The stern line is fastened to an after cleat and pulled astern at about a 45° angle. This line keeps the boat from moving forward.

The spring lines can help you control the boat when leaving a dock. Be sure to use spring lines when boating in waters where the tide movement is significant. The forward quarter spring line is fastened to a forward cleat and heads aft. The after bow spring is fastened to a stern cleat and heads forward.

USING FENDERS

Be sure to use enough fenders to protect your boat from damage when docking or tying it along side another boat. Fenders protect your boat from scarring the finish and cushion it from striking a solid object.

Using different size and shaped fenders will increase the protection of your boat.

An average size cruiser can use six fenders to protect it from damage.

NAVIGATIONAL HINTS

Learn to recognize the different buoys and day markers; they are the signposts of the waterways. There are two primary marking systems in use in the U.S.; the Uniform State Waterway Marking System (USWMS) used on inland waters and maintained by each state, and the Federal Waterway Marking System (FWMS) used on coastal waters and rivers and maintained by the USCG. In addition, the FWMS has two modified systems; the Western River Buoyage, and the Intercoastal Waterway Buoyage. Be sure to check with local authorities on the buoyage system in use.

The only buoys you are permitted to moor to are mooring buoys. Mooring to a navigation buoy or other navigational aid or regulatory marker is illegal.

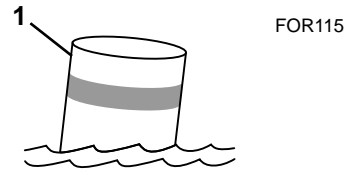

1. White with Blue Band—May Show White Reflector or Light

Mooring Buoy
Figure 7-23

The type of hazard/warning buoys and markers depend on the area of jurisdiction. Check with local boating authorities.

The USWMS Cardinal System is used when there is no well-defined channel or where an obstruction may be approached from more than one direction. With the cardinal system:

- Pass north or east of BLACK-TOPPED WHITE buoys.
- Pass south or west of RED-TOPPED WHITE buoys.
- RED and WHITE VERTICALLY STRIPED buoys indicate boats should pass outside of the buoy (away from shore).

SUN SPORT

Uniform State Regulatory Markers

USWMS regulatory markers are white with international orange geometric shapes; you must obey regulatory markers.

UNIFORM STATE WATERWAY MARKING SYSTEM (USWMS)

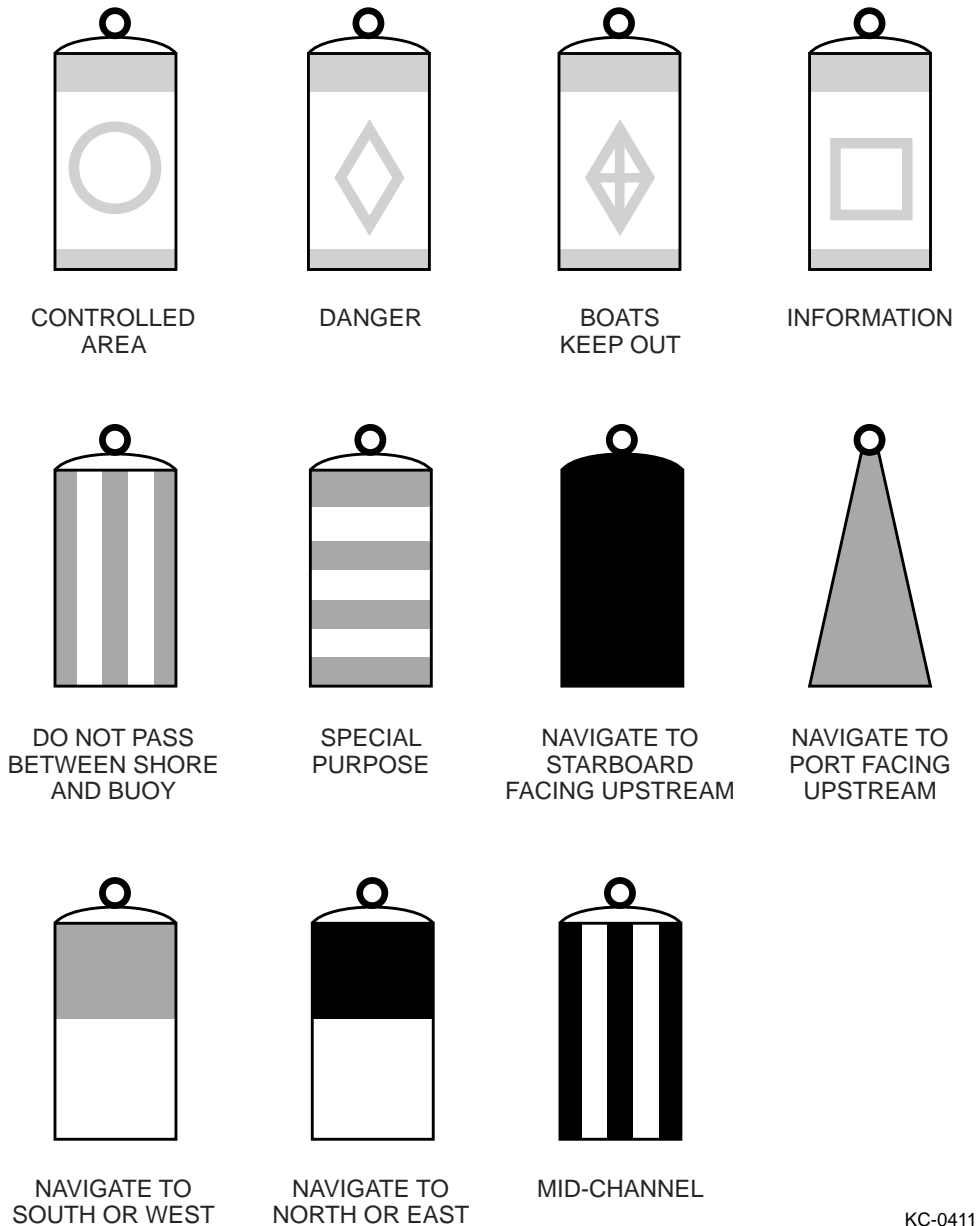

Uniform State Waterway Marking System (USWMS)
Figure 7-24

FWMS

The FWMS Lateral System is for use on navigable waters except Western Rivers and Intercoastal Waterways.

The markings on these buoys are oriented from the perspective of being entered from seaward (the boater is going toward the port). This means that red buoys are passed on the starboard (right) side of the vessel when proceeding from open water into port, and green buoys to the port (left) side.

The right side (starboard) of the channel is marked with RED, even numbered buoys. The left (port) side of the channel is marked with GREEN, odd numbered buoys.









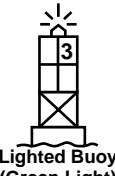
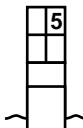

The middle of the channel is marked with RED and WHITE vertically striped buoys; pass close to these buoys.

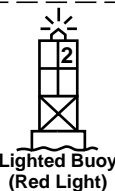
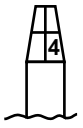
Obstructions, channel junctions, etc. are marked with RED and GREEN horizontally striped buoys.

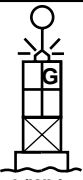
A RED band at the top means the preferred channel is to the left of the buoy; a GREEN top band means the preferred channel is to the right of the buoy.

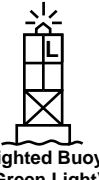
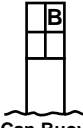
Day markers are colored and numbered the same as buoys. RED, triangular day markers with even numbers mark the starboard side of the channel. GREEN, square day markers with odd numbers mark the port side of the channel.

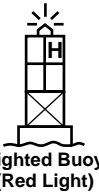
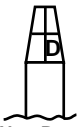
Lights, bells and horns are used on buoys for night or poor visibility conditions. Buoys with unique light flashing characteristics are identified on nautical charts with the specific flashing pattern.

Lateral Aids Marking the Sides of Channels as seen When Entering From Seaward	Port Side Odd Numbers (Green)	 Lighted Buoy (Green Light)	 Can Buoy	 Daymark
	Starboard Side Even Numbers (Red)	 Lighted Buoy (Red Light)	 Nun Buoy	 Daymark
Safe Water Aids Marking Mid-Channels and Fairways (No Numbers—May be Lettered)	(Red)	 Lighted (White Light)	 Spherical Buoy	 Daymark
Preferred Channel Aids (No Numbers—May be Lettered)	Preferred Channel to Starboard (Green and Red)	 Lighted Buoy (Green Light)	 Can Buoy	 Daymark
	Preferred Channel to Port (Green and Red)	 Lighted Buoy (Red Light)	 Nun Buoy	 Daymark

KC-0441

**Federal Waterways Marking System (FWMS)
Figure 7-25**

SUN SPORT

Light Structures

Maneuvering a boat at night can be dangerous and confusing. To aid boaters with navigation and to warn of hazards, the USCG and the state and local authorities maintain a variety of light structures. Some light structures may be equipped with radio beacons, radar reflectors, and/or signals.

Minor Lights

Minor lights are colored according to the buoyage marking system in use. They are similar to lighted buoys, except they are usually higher and on more stable platforms to increase visibility. Most minor lights are part of a series to mark a channel, river or harbor.

Range Lights

Range lights are usually visible in one direction and help a boat operator navigate in a generally safe direction. Steering a course to keep range lights arranged in a line (one on top of the other) will help guide a boat through a channel.

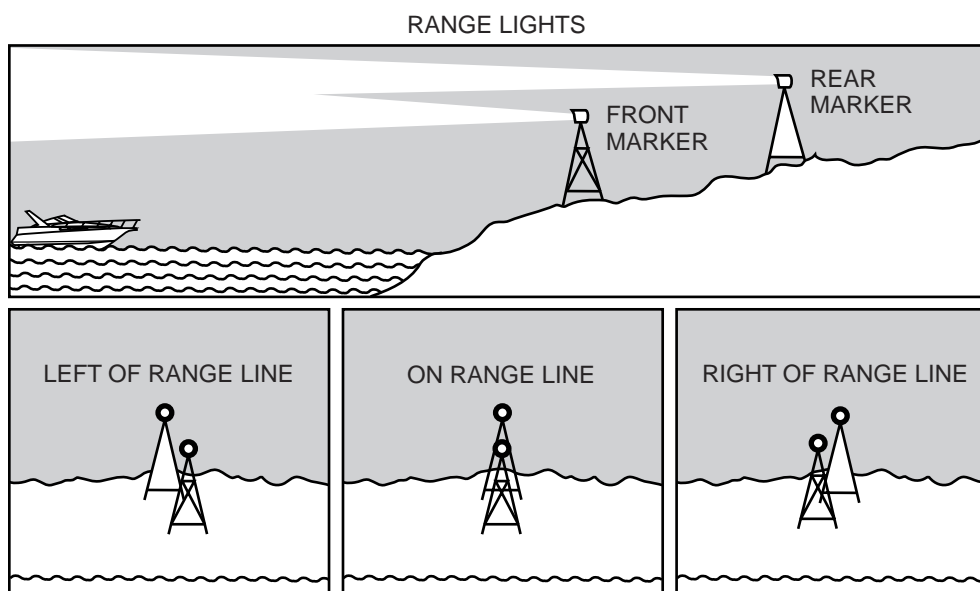

KC-0442

Range Lights
Figure 7-26

Lighthouses

Lighthouses can be found at harbor entrances, prominent headlands, isolated danger areas, and along the coast. These striped or patterned structures have unique flashing characteristics to help identify them.

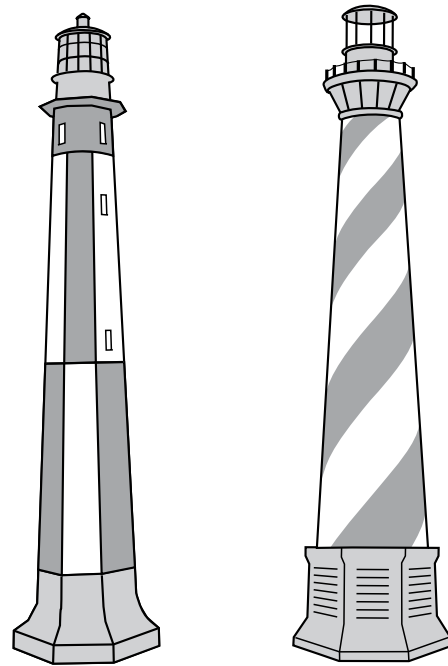

KC-0443

Lighthouses
Figure 7-27

Warning Markers

DIVERS FLAG

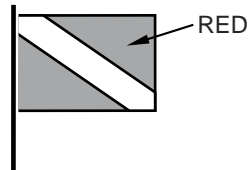

USED BY
RECREATIONAL
DIVERS -
INDICATES
DIVER'S
POSITION

ALPHA FLAG

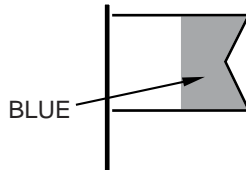

WORLDWIDE VESSELS
ENGAGED IN DIVING
OPERATIONS - DOES
NOT INDICATE
DIVER'S POSITION

DISTRESS FLAG

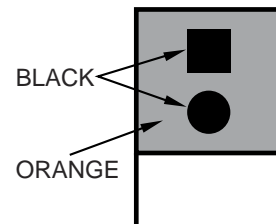

INDICATES
FELLOW
BOATER IS IN
NEED OF
ASSISTANCE

KC-0352

Warning Markers
Figure 7-28

SUN SPORT

It is a good idea to ask local authorities if there are hazardous areas and how they are marked. Boaters must also recognize the flag designs which indicate that skin divers are present and keep well clear of the area.

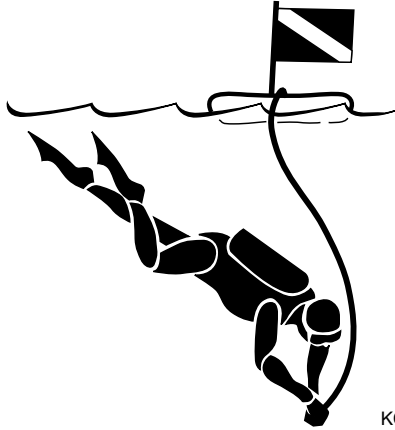

KC-0250

**Skin Diver Warning Flag
Figure 7-29**

Watch for swimmers. Swimming areas may not be marked. Steer clear from the area and remain alert.



KC-0260

**Swim Area Warning Buoy
Figure 7-30**

Navigation markers serve as a means of identifying navigable routes, and indicate water hazards. Boaters should become familiar with navigation markers and stay within marked boundaries and clear of hazards.



Section 8

Schedule Checks and Service

Use the checks and maintenance information outlined in this section along with service information contained within the individual component operator's manuals supplied in your Owner Information Binder. It is extremely important that you read and understand the periodic maintenance tasks outlined in your operator's manuals (propulsion unit, generator and other accessories) because those maintenance tasks are not repeated in this manual.

AFTER EACH RUN

Perform the following tasks after each run.

- Fill fuel tanks to prevent moisture due to condensation.
- To prevent marine growth from accumulating on the hydraulic cylinder shafts, make sure trim tabs are UP and propulsion unit drives are in the full IN position.
- Stow and secure all equipment.
- Pump bilge dry with manual control switch.
- Close all water inlet seacocks.
- If possible, inspect the hull and propellers for damage.
- Check for fuel, oil and water leakage.
- Clean any spills, stains or moisture from the boat. Inspect sea strainers.
- Turn battery selector switches OFF.
- Secure lockers, hatches and canvas as equipped.

SCHEDULED MAINTENANCE CHECKS

This chart is based on average operating conditions. Shorten the intervals if operating in salt water or other severe operating conditions.

Frequency	Task
Break-in	Refer to propulsion unit operator's manual.
	Refer to generator operator's manual.
Before Every Use	Test operation of carbon monoxide detector(s).
	Test operation of fume detector.
	Check remote control for proper operation.
	Check seacocks for leaks and ensure handles are secure.
	Check seawater strainers for leaks and accumulation of debris.
	Check generator's fuel/water separator.
	Check exhaust system for leaks.
	Check fuel system for leaks.
Every 50 Hours	Clean seawater strainers.
	Inspect propellers for damage.
Every 100 Hours	Test for proper operation of the ignition safety switches, if equipped.
	Clean bilge area.
Monthly	Test GFCI outlets.
	Check self-sacrificing anodes.
Quarterly	Have your Formula dealer perform scheduled maintenance as outlined in this section.

SUN SPORT

Break-In

Careful break-in allows internal engine components to “seat” properly, resulting in maximum engine life and performance. Refer to the propulsion unit and generator operator manuals for manufacturers’ break-in requirements.

Before Each Use

1. Test for proper operation of the carbon monoxide detector(s). Refer to the carbon monoxide detector operator’s manual.
2. Test for proper operation of the fume detector. Refer to the fume detector operator’s manual.
3. Check the remote control for proper operation and maintenance following the manufacturer’s recommendations.

⚠ WARNING

Improperly maintained remote controls are hazardous and may cause sudden loss of control. Make sure all shift/throttle hardware and cables are regularly inspected and maintained. Improper maintenance may result in a loss of control, resulting in serious injury or death.

4. Check all seacocks and hoses for leakage. If you notice a leak, contact your Formula dealer.

CAUTION

- Seacocks can only be replaced when the boat is out of the water.
- Be sure a seacock is in the closed position before replacing a hose.

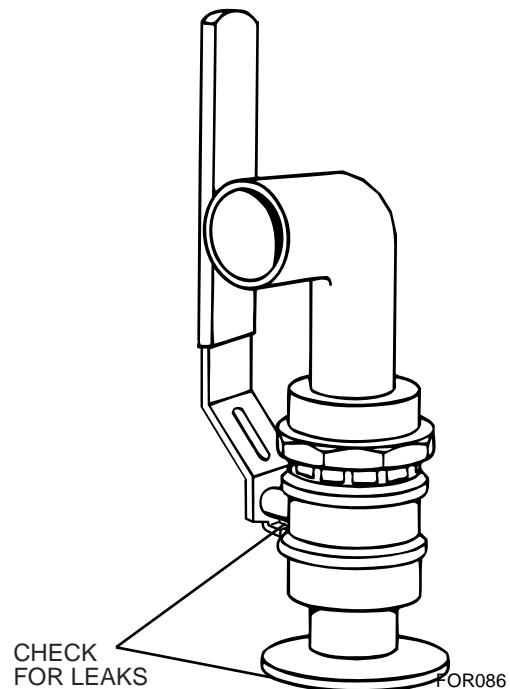

**Seacock
Figure 8-1**

5. Check all seawater strainers for leaks and accumulation of debris.

SCHEDULE CHECKS AND SERVICE

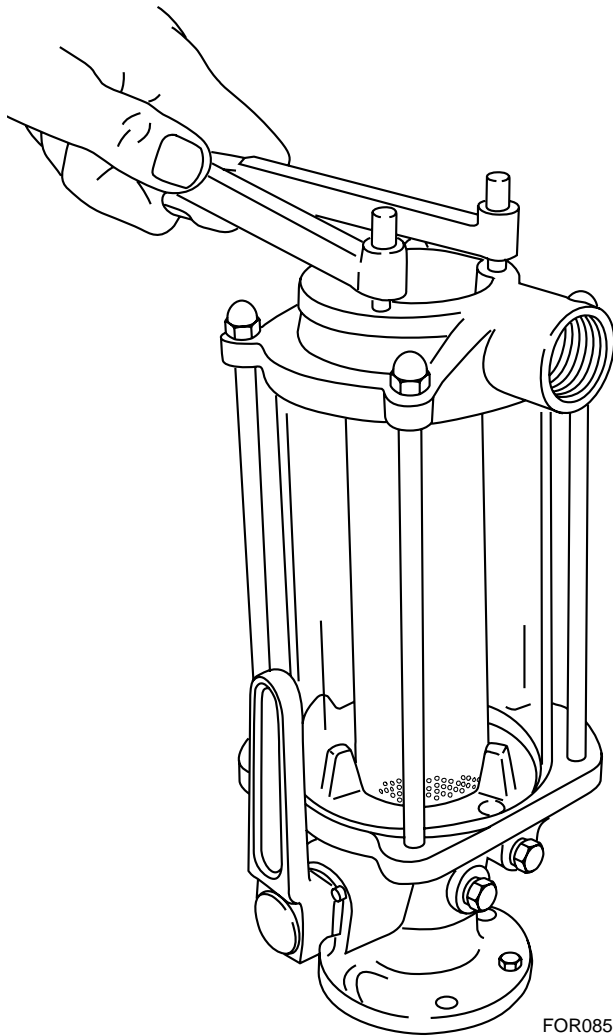

Seawater Strainer
Figure 8-2

- If a hose is leaking or damaged, close the appropriate seacock. Contact your Formula dealer for repairs.
- If debris is seen within the container, close the appropriate seacock and remove the strainer cover. Lift strainer from container and thoroughly clean. If the container is full of sediment, remove the plug at the bottom of the container and allow water to drain into the bilge. Remove the container and clean any sediment. Install the container and plug. Install strainer in container and secure cover. Open the seacock and check for leaks.

CAUTION

Seacock must be in the closed position before servicing a strainer.

6. Start the engine(s) and the generator, if equipped. Check all exhaust systems for leakage. If you notice a leak, contact your Formula dealer.
7. Check all fuel lines and connections at fuel tanks, engines and the generator for leakage. If you detect a fuel leak, immediately contact your Formula dealer.

⚠ WARNING

Do not operate your boat when a fuel leak is detected. All fuels are combustible. A fuel leak must be repaired before starting the engines or the generator.

8. Check charge of all the batteries. Be sure the batteries can start the engines and the generator, if equipped, before proceeding on your cruise.

Every 50 Hours

1. Be sure to clean seawater strainers.
2. Check propellers for damage. If bends, cracks or other damage are found, contact your Formula dealer for service. Do not continue to use badly damaged propellers. Using damaged propellers may damage the drive units.

Every 100 Hours

Clean the bilge area. Make sure all drain passageways are clear.

Monthly

⚠ WARNING

With the engines running, pull the lanyard off the ignition safety switch. Both engines must stop running. If neither or only one engine stops running, immediately contact your Formula dealer for service.

1. Test each GFCI outlet circuit breaker feature. Push the test button on each outlet. Power should be interrupted to all the outlets onboard. Press the reset button to restore power. If power is not interrupted, consult your Formula dealer.

SUN SPORT

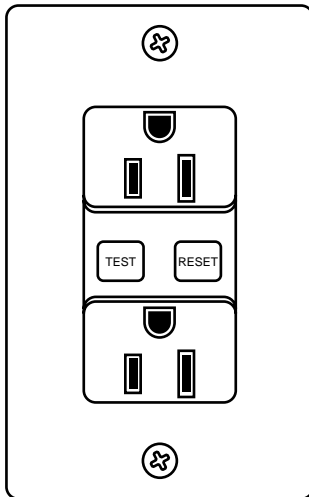

FOR054

**GFCI Outlet
Figure 8-3**

2. Check the condition of all self-sacrificing anodes (commonly referred to as “zincs”). If an anode shows deterioration of 50% or more, it must be replaced. Refer to the propulsion unit operator’s manual for additional information.

Quarterly

Have your Formula Dealer perform the following scheduled maintenance.

⚠ WARNING

The steering system is the most important system on the entire boat from a safety standpoint. Have the system inspected and maintained on a quarterly basis by a qualified service technician.

1. Clean the fresh water filter.
2. Fill, pressurize and inspect the freshwater system for leaks and proper component operation.
3. Inspect the steering, shift and throttle systems for proper operation.
4. Check all batteries for proper electrolyte level.
5. Check trim tab pump fluid level.



Section 9

Care and Maintenance

This section describes how to care for and maintain your Formula boat. As the owner of a Formula boat, you have purchased a boat that is easy to clean and maintain. Periodic cleaning will make a large contribution toward your boat's future value as well as add to the enjoyment you experience while using your boat. This is the best way to maintain your Formula's original, "like new" condition.

CAUTION

Certain automotive, household and industrial cleaners can cause further damage and discoloration. Solvents and dry cleaning fluids, or products that contain dyes such as waxes, should be used with caution. Be sure to test cleaners in an unseen area first. The following stain treatments should be used with discretion. Between steps, be sure to rinse thoroughly with clean water and allow to dry.

INTERIOR CLEANING

CAUTION

Most cleaners require adequate ventilation during use. Open all hatches, windows and doors before cleaning.

Carpet

All Formula cockpit carpet is heavy duty, all weather indoor/outdoor type carpet resistant to fading. Cabin carpet is high quality indoor carpet, resistant to staining and wear. Periodic cleaning with a vacuum will restore the original beauty. Use household carpet stain removers and cleaners to clean the carpet.

Cabin Upholstery

Your cabin lounge upholstery is made of UltraLeather HP™. UltraLeather is a tough and durable product that is easy to maintain.

For spots and spills, wipe up liquid using a clean absorbent cloth or sponge. Spot clean with mild soap and water. Allow the seat to air dry. If needed, you may use a hair dryer on the warm setting. For stubborn stains, use a mild solvent and follow the instructions on the label.

Type of Stain	Mild Detergent	Mild Cleaning Solvent
Coffee, Tea	■	
Red Wine, Liquor	■	
Soft Drinks	■	
Milk	■	
Ketchup	■	
Steak Sauce, Soy Sauce	■	
Mayonnaise, Butter	■	■
Salad Oil	■	■
Chocolate	■	■
Cosmetic Foundation	■	■
Lipstick	■	■
Face Cream	■	■
Suntan Lotion	■	■
Shoe Polish	■	■
Urine	■	■
Machine Oil		■

SUN SPORT

Cabin Options

Refrigerators, stoves, microwaves and other appliances have individual instruction manuals in your Owner Information Binder. These instruction manuals list the proper care and maintenance of the appliance. If you have any questions after reading the instruction manuals, contact your Formula dealer for assistance.

EXTERIOR CLEANING

Proper care and prevention is the best way to take care of your Formula's finish.

Vinyl Upholstery

CAUTION

Suntan lotion and insect repellents can cause rapid staining and deterioration of the vinyl surface. Remove these products immediately after contact. Wash the area with mild soap solution, rinse with clean, warm water and then towel dry.

Your cockpit upholstery is made of Nautolex® marine vinyl. Nautolex is a cleanable, stain-resistant vinyl product designed to take the extremes of weather and still provide years of dependable service with normal use and care. Even though it is designed to take punishment, it can be damaged if a sharp object contacts it.

The Nautolex vinyl upholstery may have PreFixx® protective finish applied to it. Ask your Formula dealer for additional information.

Each week, wipe Nautolex surfaces with a soft damp cloth and towel dry. In very rainy weather, cover or remove the cushions to prevent the seams from trapping and absorbing moisture. Cushions should be stored in a dry, well-ventilated place.

Special Cleaning Instructions—For dirt and stains that cannot be removed with a damp cloth:

- Step 1.** Use mild soap and water and, if necessary, a soft-bristle brush.
- Step 2.** Any stains still remaining should be immediately cleaned with isopropyl (rubbing) alcohol. After using mild soap or isopropyl alcohol, rinse off any remaining residue with a damp cloth and towel dry.

- Step 3.** If a residual stain remains, and your vinyl upholstery is protected with PreFixx, use fingernail polish remover containing acetone. If the stain has not become permanent, it should be removed after rubbing the spot 5 or 6 times. Do not continue to rub a spot with fingernail polish more than 6 times. Additional rubbing could possibly damage the vinyl finish.

CAUTION

Do not use abrasive powders, steel wool, undiluted bleach, lacquer solvents, industrial strength or solvent cleaners or vinyl "conditioners" or "protectants" to clean your vinyl upholstery.

Recommended cleaning solutions for Nautolex.

Type of Stain	Cleaning Steps for Nautolex	Nautolex with PreFixx
Spray paint	1-2	1-2-3
Ballpoint pen	1-2	1-2-3
Lipstick	1-2	1-2-3
Yellow mustard	1-2	1-2-3
Bird droppings	1-2	1-2-3
Suntan lotion*	1-2	1-2-3
Insect repellent	1-2	1-2-3
Crayons	1-2	1-2
Eye shadow	1-2	1-2
Oily soot	1-2	1-2
Petroleum products	1-2	1-2
Coffee, tea	1	1
Grape juice	1	1
Baby and olive oil	1	1
Chocolate	1	1
Ketchup	1	1
Hair oil tonic	1	1
Blood	1	1
Urine	1	1

* Independent laboratory testing has shown that most sunscreen lotions and oils can permanently stain vinyl products including those protected by PreFixx.

CARE AND MAINTENANCE

Hull/Deck

The high-lustre finish on your Formula boat is called gelcoat. Gelcoat can be easily maintained by washing the surface with mild (non-abrasive) detergent on a regular basis. Do not use abrasive cleaners, solvents, ammonia or chlorine as these will scratch and dull the gelcoat surface.

Wax the entire gelcoat surface with a good-quality marine wax at least once a year after a thorough cleaning. Use of a specially formulated marine gelcoat wax will prevent color fade, and soil and scum adhesion.

Your boat will actually perform better with a clean waxed bottom. If a heavy algae is noticed on the bottom, your Formula dealer can recommend a good remover for your particular area.

Extended in-water storage increases the risk of osmotic blistering of the hull's gel coat surface. Consequently, owners whose boats will remain in the water for several months at a time should consider applying barrier coat materials or a protective paint to the hull below the water line.

When taking your boat out of salt water, the entire boat should be washed down with fresh water immediately. This includes the deck, hardware and any surface exposed to the salt water.

To extend the life of your gelcoat finish, cover your boat with a mooring cover for maximum protection. A tonneau cover will only protect the cockpit interior, not the gelcoat finish. Your Formula dealer can supply more information on this subject.

Canvas

In most cases, boat canvas is subjected to more abuse than any other item on the boat. Canvas must be maintained for long life and top performance.

CAUTION

Do not place canvas in hot water or run it through the hot drying cycle of an automatic dryer. Fabric should be line dried. Do not have fabric steam pressed at a dry cleaners.

Formula canvas sets are made from the highest quality Sunbrella® canvas and clear vinyl. With the proper care, this canvas will last you many seasons. Each canvas set is custom fit to each boat to assure a proper fit.

The outer canvas surfaces can be cleaned with a soft scrub brush and mild detergent. The underside of the canvas should be sprayed periodically with a disinfectant to prevent the growth of mildew. Do not use cleaners on clear vinyl curtains and windows. Wash with clean water and a soft, clean cloth.

NOTICE

Do not use any abrasive cleaner on the front, side or aft curtain as it will scratch or mar the clear vinyl surface.

Moisture, dirt, heat, ultraviolet rays, salt water and chemicals from industrial fallout can all contribute to the deterioration of canvas. These elements can cause serious damage if left unattended. Follow these guidelines to keep your canvas in good condition.

NOTICE

Wet canvas must be allowed to dry thoroughly before storage. Do not allow canvas to dry loose since shrinkage can occur. Canvas must be erected on the boat when drying.

- The convertible top is not designed to withstand long periods of time exposed to the elements and direct sunlight. It is not designed to be a protective cover. Use a full, properly fitted mooring cover for these purposes.
- If the canvas gets wet during storage, remove the side curtains and open the windshield to allow seams to dry out. The air circulation will allow all canvas to dry and prevent the growth of mildew. Do not store folded or rolled up damp canvas.
- Occasionally set up all canvas and curtains and hose down with fresh water to remove accumulated soot and dirt. Sweep or brush the underside of the canvas to prevent the accumulation of dirt and mildew.
- Do not store or dock your boat under trees. Tree sap is very corrosive to canvas and can also be harmful to gelcoat and vinyl interiors.
- Adjust the top bows to eliminate pockets in which rain water can accumulate. The weight of this accumulated water can collapse the top or sag the canvas.
- Do not trailer your boat with the convertible top in the mounted position. All canvas should be dismantled, rolled and properly stored while trailering your boat to prevent wind damage.

SUN SPORT

When setting up the canvas, be sure to zip in the side and aft curtains before using the snaps. Snaps and zippers should be regularly lubricated with Vaseline, silicone spray or paraffin.

Do not force zippers. The most vulnerable part is the starting point. Be careful when starting a zipper to prevent damage.

Hardware Care

Deck fittings, cleats and bow rails are stainless steel. Frequent washing with a mild detergent should bring back the original shine. Remove rust spots as soon as possible with a brass, silver or chrome cleaner. Apply a coat of wax to protect the finish.

NOTICE

Do not use coarse abrasives like sandpaper or steel wool, or cleaning agents like mineral acids or bleaches to clean stainless steel. Do not allow stainless steel components to contact iron, steel or other metals which can cause stainless steel to rust or corrode.

Periodically check deck fittings, cleats and bow rails for tightness. Have your Formula dealer tighten any loose items.

Radar Arch

Depending on your model boat, the radar arch is constructed from either aluminum or fiberglass and has a very durable finish. Wash the arch with a mild detergent and a clean soft cloth. Apply a non-abrasive wax to the finish.

Windows and Windshield

All Formula windshields, wing windows and walk-through windows are of tempered glass construction. They can be cleaned with a non-abrasive glass cleaner applied with a soft cloth. Do not use a dry cloth or a harsh detergent. These items will scratch the surface.

Marine Growth

If accelerated marine growth is a problem in your area, an anti-fouling bottom paint may be necessary to slow growth and prevent gelcoat damage. Consult your Formula dealer for anti-fouling bottom paint recommendations.

UNSCHEDULED MAINTENANCE

Periodically check cleats, seats, fittings, windshield mounting hardware and other items for tightness and proper operation. A problem with a piece of equipment can occur at anytime. Have your Formula dealer service a problem. The safety of you and your passengers depends upon a well maintained boat.

Immediately service any problem with an engine, propulsion unit or generator. A minor repair could become a major overhaul if left unchecked. Pay close attention to the cooling system operation of these components.

Propulsion Units and Generator

Follow the maintenance schedules outlined in your propulsion unit and generator operator's manuals. Obtain the required service at the specified interval from your Formula dealer.

Electrical System

WARNING

Use extreme caution when checking for an electrical problem.

An electrical system problem must be treated seriously. Do not operate your boat knowing there is a problem with the system. When a problem is discovered, have your Formula dealer service it immediately.

NOTICE

The electrical system is designed to protect you from short circuits and overloads. Any modifications to the system, such as adding electrical accessories should be done by a qualified technician.

Batteries

WARNING

Batteries contain sulfuric acid which can cause severe burns. Wear eye protection and protective clothing to avoid contact with skin.

CARE AND MAINTENANCE

Check the batteries frequently for signs of corrosion. If corrosion is found, clean terminal posts with a baking soda and water solution and a wire brush. Before cleaning, remove the vent caps and seal the vent wells with corks to prevent the solution from getting inside the battery.

NOTICE

Some batteries are sealed and cannot be filled.

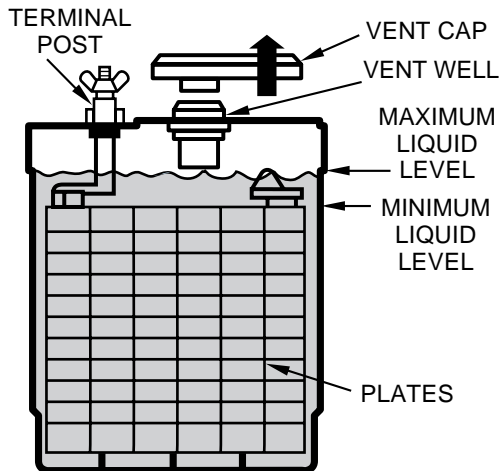

Battery
Figure 9-1

KC-1620

Check the fluid levels in the battery cells. A level approximately 1/4 to 1/2 in. (6 to 13 mm) above the plates is sufficient. If needed, fill with distilled water. Do not overfill.

⚠ WARNING

Batteries produce explosive hydrogen gas. Do not attempt to start an engine with jumper cables under any circumstances. Keep all sparks, flames and smoking material away from batteries. The risk of a spark at the battery post, igniting gasoline or hydrogen fumes, is too great.

Circuit Breakers

All electrical circuits are protected from overload by the use of circuit breakers. In the event of an overload or short circuit, the circuit breaker will trip. You should determine and correct the cause of a problem before resetting the circuit breaker. Contact your Formula dealer if a circuit breaker continues to trip.

CAUTION

Determine and correct the cause of a problem before resetting a tripped circuit breaker.

To reset a push-button circuit breaker at the remote circuit breaker panels, wait about one minute for the breaker to cool. Push the breaker button in fully.

To reset a switch-type circuit breaker at the cabin distribution panel, wait about one minute for the breaker to cool. Push the breaker tab back into place.

Some accessories, such as the stereo, have a fuse located in the positive lead. Refer to the accessories operator's manuals in your Owner Information Binder for the location of in-line fuses.

⚠ WARNING

Do not exceed the recommended fuse size or bypass the fuse safeguard. Install the proper type and rating fuses whenever replacing or changing fuses. Continuous fuse failure indicates a severe problem and requires immediate attention. Failure to install the correct fuse may result in damage to the electrical system or personal injury.

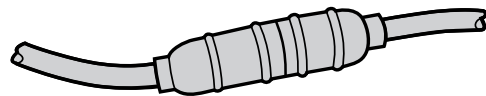

(TWIST AND PULL TO OPEN)

KC-1640

Typical In-Line Fuse Holder
Figure 9-2

SUN SPORT

Fuel System

WARNING

All fuels are combustible. Check the fuel system before each use. Do not operate the boat when a fuel leak is found. A fuel leak must be repaired before starting the engines or generator.

The fuel system should be inspected before each use. Fuel lines, fuel filters and other fuel system components should be checked for leaks. Fuel vents must be free from obstructions. Surface cracking on a fuel hose indicates wear and must be replaced. Use fuel system parts certified for marine use. Do not substitute automotive parts in a marine application.

Water System

Fresh Water—The following maintenance should be performed each month to keep the fresh water system clean and sanitary:

- Use the faucets and shower to drain the fresh water tank completely. Refill the tank with at least 20 gallons of clean, fresh water and drain again.

If the water in the tank has been allowed to stagnate and you suspect that the fresh water system may be contaminated, sanitize the system.

- Drain the fresh water tank completely.
- Mix a solution of 2-1/2 cups (20 oz.) of household bleach to 10 gallons of water. Pour the solution into the fresh water tank.
- Fill the tank with clean, fresh water.
- Turn the fresh water pump ON and bleed the air from all faucets and showers. Start with the faucet farthest from the pump.
- Allow the solution to stand for 3 to 4 hours. Drain the system completely.
- Flush the system with at least one full tank of water.
- Fill the tank with clean, fresh drinking water.

If you smell or taste bleach in the water:

- Drain the system completely.
- Mix a solution of one quart of white vinegar to 5 gallons of water. Pour the solution into the tank.
- Allow the solution to remain in the tank for several days.
- Drain the system completely.
- Flush the tank with at least one full tank of water.
- Fill the tank with clean, fresh drinking water and bleed the air from all lines.

Gray Water—Make sure the waste system is always operating properly. Periodically check the level of waste water and have the tank pumped out when needed.

BILGE

The bilge accumulates oil and greasy dirt over a period of time. Usually, ordinary soap and water will not remove the accumulation. The use of a stronger detergent is necessary. Consult your Formula dealer for recommendations on special bilge cleaning products.

CORROSION AND ELECTROLYSIS

Corrosion destroys underwater metal parts and can occur in fresh or salt water. However, salt, brackish and polluted waters will accelerate corrosion.

Galvanic corrosion (electrolysis) can result in serious damage to any metal component of your Formula boat that is in the water. Galvanic corrosion is the deterioration of metals due to the effects of electrolytic action. When dissimilar metals are immersed in a conductive fluid such as salt water, an electric current is produced, similar to the action of a battery. The softest of the metals will be the first to become damaged.

CARE AND MAINTENANCE

GALVANIC CORROSION PROTECTION

NOTICE

Refer to the propulsion unit operator's manual for their requirements for galvanic corrosion protection.

A self-sacrificing anode can be mounted to your Formula boat to help prevent damage to metal components from galvanic corrosion. The anode will require frequent inspections. If the anode shows deterioration of 50% or more, it must be replaced for continued protection.

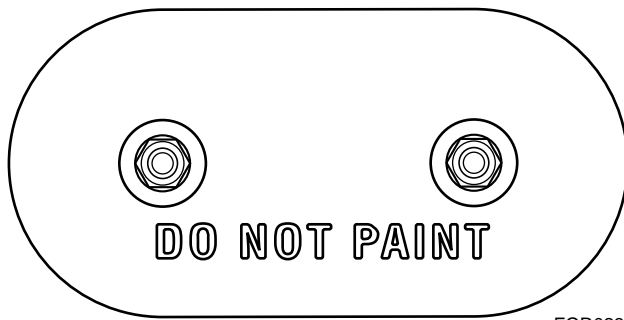

FOR023

Self-Sacrificing Anode
Figure 9-3

CAUTION

Do not paint an anode, its fasteners or its mounting surface. Painting will reduce the anode's corrosion protection capabilities.

Wash the entire boat after each use in salt water. If you continue to operate in salt water, the entire boat should be protected against salt water damage as described in **Exterior Cleaning**, in this section.

SUN SPORT



Section 10 Storage

Storage/winterization requires special preparation to prevent damage to the boat, propulsion units, generator and other equipment. Perform all annual maintenance at this time.

Without proper preparation, storage for long periods of time may cause internal parts of the engine and drive units to rust due to a lack of lubrication. Water inside the bilge or cooling system may also freeze causing damage to components if the boat is stored in below freezing temperatures. Damage to the boat due to improper storage will not be covered by the warranty. The following procedures should help prevent damage to your boat.

IN-WATER STORAGE PREPARATION

While the boat is still in the water, fill the fuel tanks and add the proper amount of fuel stabilizer and conditioner. Follow the instructions on the label. Operate the engines and generator for at least 15 minutes to be sure the treated fuel has reached them.

NOTICE

Follow the engines and generator's recommendation for treating the equipment with a rust preventative fogging oil. Fogging oil should be used if the boat is to be stored in a high moisture (humidity) environment, in extreme temperatures or stored outdoors.

LIFTING THE BOAT

To prevent structural damage to your Formula boat, the proper procedure must be used when lifting your boat. The recommended method of removing the boat from the water is to use lifting slings. Slings must be the flat, wide belting-type. Do not use cable-type slings. The spreader bars used with the slings must be long enough to avoid pressure to the gunwales.

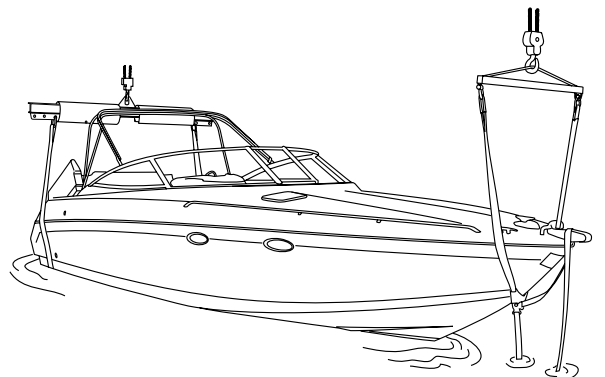

FOR217

1. Spreader Bar

Lifting with Slings
Figure 10-1

SUN SPORT

STORAGE CRADLE

A storage cradle will provide proper support and prevent stress on the hull. Position the storage cradle as close to the sling tag locations as possible. Use caution not to damage any underwater fittings.

The storage cradle must completely touch the hull for proper support. Avoid any gaps between the cradle and the hull.

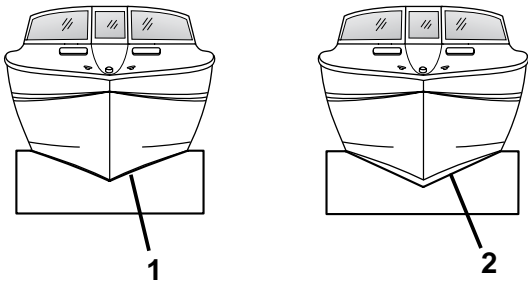

1. Hull completely on cradle—right
2. Gap between hull and cradle—wrong

Storage Cradle
Figure 10-2

Store your Formula boat on a storage cradle with the bow elevated. Remove the transom drain plug. Be sure all compartments in the bilge drain completely to prevent mold and mildew. Mold and mildew may form as a result of the inability of moisture to escape.

STORAGE/WINTERIZATION

Preparing for winter lay up is important. In frigid zones, be particularly attentive to items that can be damaged by freezing. Freeze damage is not covered by warranty.

1. After the boat has been properly positioned on a storage cradle, thoroughly wash the hull, deck and interior compartments. Allow a couple of days of air drying before covering the boat. Store all cushions in the open position and open all storage areas. This will help prevent mold/mildew from forming. Perform preventative maintenance to the interior and exterior of your boat following the information in **Care and Maintenance**, in **Section 9**.
2. Refer to the propulsion unit manufacturer's storage recommendations.

3. Open all faucets and allow the fresh water pump to empty the water tank and water lines.
4. Remove strainer and seacock drain plugs. Open all drains and seacocks.
5. Remove the batteries from the boat. Clean and check their condition. Store the batteries in a cool, dry place, out of direct sunlight. Do not store the batteries close to heat, spark or flame producing devices. Check the electrolyte level and charge them periodically during the storage period.
6. Cover the boat with the mooring cover. If a temporary poly cover, such as shrink wrap is used, vents must be installed to provide adequate ventilation to prevent mold or mildew.

RE-ACTIVATING THE BOAT AFTER STORAGE

There are many systems that require special attention to ensure your boat is in proper operating condition.

1. Refer to the manufacturer's recommendations and prepare the following items for use:
 - Carbon monoxide detector(s)
 - Fume detector
 - Engine's cooling, exhaust and lubrication systems

It is very important the engine fuel system and exhaust system be thoroughly inspected and repaired, if necessary, before operating the boat. Also, all of the accessory exhaust systems must be in proper operating condition.

⚠ WARNING

Failure to inspect the fuel system could allow fuel leakage to go undetected, becoming a fire or explosion hazard.

⚠ DANGER

Carbon monoxide gas (CO) is colorless, odorless and extremely dangerous. All engines and fuel burning appliances produce CO as exhaust. Direct and prolonged exposure to CO will cause BRAIN DAMAGE or DEATH. Signs of exposure to CO include nausea, dizziness and drowsiness.

2. Make sure the batteries are fully charged before installing.
3. Fill the fresh water tank then check the system for proper operation.
4. Install the strainer and seacock drain plugs. Open and close the seacock to check operation.
5. Check condition of all hoses and make sure all hose clamps are tight.
6. Check for proper operation of the steering, shift and throttle systems.
7. Check condition of all fire extinguishers.
8. Check drive unit and trim tab fluid levels.

SUN SPORT



Section 11

Troubleshooting

The chart in this section is designed to assist you in locating and repairing minor mechanical, electrical and boat system problems. Special tools and trained personnel may be required to correct some problems. Please have your Formula dealer assist you with service issues.

Your Formula boat is equipped with an ignition safety switch (one per engine). Make sure the lanyard(s) is installed on the switch. Please contact your Formula dealer for assistance.

Engine

For further troubleshooting information other than what is given here, refer to the propulsion unit operator's manual.

⚠ WARNING

- **Gasoline is flammable. Use extreme caution when handling gasoline.**
- **Use extreme caution when checking for electrical problems.**
- **Battery acid can cause blindness if splashed in eyes; may burn skin.**
- **Disconnect battery cables at the battery before making checks or adjustments around the engines and electrical components.**

SUN SPORT

Symptom	Possible Cause
Engine will not crank	Lanyard – install on ignition safety switch.
	Battery switch – turn to ON position.
	Shift position – check to see that lever is in start or NEUTRAL position.
	Battery condition – battery must be fully charged.
	Starter connections – check connections and tighten. If solenoid clicks when attempting to start engine, check battery connections. If condition persists, see your Formula dealer.
	Engine circuit breaker – breaker must be in operating position.
	Faulty ignition switch – see Formula dealer.
	Engine problem – see your Formula dealer.
Engine cranks but will not start	Contaminated fuel – see Formula dealer.
	Engine problem – see Formula dealer.
Low starter speed	Weak or bad battery – see Formula dealer.
Engine runs erratically	See your Formula dealer.
Engine vibrates	Propeller condition – shut off engine. Check for bent, broken or damaged propeller. Check for weeds on propeller.
	Engine problem – see Formula dealer.
Engine runs but boat makes little or no progress	Fouled or damaged propeller – shut off engine. Check for weeds on propeller, bent or broken propeller. See your Formula dealer.
Performance Loss	Throttle(s) not fully open – check to see that throttle opens fully at engines.
	Improper fuel – fill tanks with correct fuel.
	Overheating – immediately turn OFF the engine and contact your Formula dealer.
	Boat overloaded – reduce load.
	Boat trim – distribute boat load evenly.
	Improper propeller selection – see Formula dealer.
	Excessive bilge water – check for excessive water, drain bilge.
	Boat hull condition – clean if marine growth is present.
Lack of power	Throttle not fully open – adjust throttle linkage.
	Contaminated fuel – drain fuel tank and lines. Flush with clean fuel and replace fuel filters.
Hard shifting	Corroded or pinched linkage.

TROUBLESHOOTING

Electrical

CAUTION

Correct a problem with the electrical system before resetting a circuit breaker.

Symptom	Possible Cause
Electrical component will not function	Circuit breaker tripped or in the OFF position – correct the problem and reset; turn circuit breaker ON.
Dim or no lights	Circuit breaker tripped or in the OFF position – correct the problem and reset; turn circuit breaker ON.
No AC power	Circuit breakers tripped or in the OFF position—correct the problem and reset.
	Ground fault circuit interrupter tripped—reset button on the outlet and test. If problem exists—see Formula dealer.

Plumbing

Symptom	Possible Cause
No water at shower or sinks	Fresh water pump circuit breaker tripped or in the OFF position – correct the problem and reset; turn circuit breaker ON.
	Fresh water tank empty.
	Fresh water pump defective – see Formula dealer.
	Filter plugged – clean filter.
Low water pressure at all sinks and shower	Damaged fresh water pump – see Formula dealer.
Low water pressure at only one sink	Restriction or obstruction in water line.
Head will not flush	Head circuit breaker tripped or in OFF position – correct the problem and reset; turn circuit breaker ON.
	Line to waste tank blocked – see Formula dealer.
	Holding tank full - pump out tank.

SUN SPORT



Section 12

Warranty and Service

Each Formula is protected by a combination of original manufacturers' warranties and supplemental product protection, which provides comprehensive coverage for a minimum of five years from the boat's original purchase date. In general, Formula and the boat's major component manufacturers (engines, transmissions, generator) administer warranty for the first year of ownership. Thereafter, a supplemental product protection plan – Formula Guard – takes over, providing extended coverage for many factory-installed accessories and components, including the major components noted above. Following is a general breakdown of warranty coverages:

Item Description	Administrator	Coverage Period
Most component materials and small purchased parts and accessories	Formula (1st year only) and Formula Guard Administrator (years 2-5)	Total of five (5) years
Propulsion system components (engines, outdrives, transmissions), major electronics and appliances (generator, GPS, radar, autopilot, refrigerator, ice maker, etc.	Original Manufacturers (1st year only) and Formula Guard Administrator (years 2-5)	Total of five (5) years (see manufacturers' literature for specifics regarding original warranties' duration)
Materials used in fabrication of Thunderbird-produced canvas products (e.g., cockpit covers, storage coves)	Formula	Two (2) years
Gel coat finish - protection against osmotic blistering, air voids, and crazing/cracking if attributed to manufacturing defect	Formula	Two (2) years
Materials used in fabrication of Thunderbird-produced cockpit seating structures (e.g., vinyl, foam, and thread)	Formula	Five (5) years
Hull and deck structural elements, including stringers, supporting bulkheads, and fiberglass matrix grid systems	Formula	Ten (10) years

SUN SPORT

THUNDERBIRD LIMITED WARRANTY POLICY

Beginning in model year 2004, FORMULA boats, by THUNDERBIRD PRODUCTS, are warranted to the original retail purchaser for a period of:

- One (1) year – general defects in materials and workmanship, including most materials, components and accessories used in the boat's construction.
- Two (2) years - materials used in the fabrication of any canvas product manufactured by THUNDERBIRD PRODUCTS (i.e., cockpit covers, storage covers).
- Two (2) years – gel coat finish, to include protection against osmotic blistering, air voids, and crazing/cracking if attributed to manufacturing defect.
- Five (5) years - materials (e.g., vinyl, foam, and thread) used in cockpit seating structures manufactured by THUNDERBIRD PRODUCTS.
- Ten-years (10) - hull and deck structural defects. Structural elements include stringers, matrix grid systems, bulkheads, and pultrusions.

Each warranty period listed above begins on the date of delivery to the original retail purchaser. **These warranties exist provided that the purchaser has used, maintained and stored the same in accordance with THUNDERBIRD'S recommendations and procedures described in the FORMULA Owner's Manual.**

During these periods, the warranty repairs shall be made at the dealer's store or service center, or at THUNDERBIRD'S option at the THUNDERBIRD manufacturing plant. Transportation charges on FORMULA boats, if any, to and from the dealer's service center or to and from the THUNDERBIRD manufacturing plant, shall be the sole responsibility of the owner.

This warranty may be transferred to a second or subsequent owner of the boat provided that the second or subsequent owner notifies THUNDERBIRD in writing within 30 days of the change of ownership and pays THUNDERBIRD the established transfer fee. A transferred warranty shall be limited in duration to the periods set forth herein, and the second or subsequent owner shall be required to use, maintain and store the boat in the manner described above.

All repairs under the terms of this warranty are subject to authorization of the factory-trained personnel whose decision shall be final in all events.

The sales personnel or other employees of the selling FORMULA dealer are not authorized to make warranties concerning FORMULA boats. The dealer's employees' ORAL STATEMENTS DO NOT CONSTITUTE WARRANTIES, shall not be relied upon by the purchaser, and are not part of the contract of sale. The dealers are not agents of THUNDERBIRD. NO OTHER WARRANTIES ARE GIVEN BEYOND THOSE SET FORTH HERIN.

THE WARRANTY PROVIDED HEREIN IS IN LIEU OF ALL OTHER EXPRESS WARRANTIES AND MAY NOT BE EXTENDED OR MODIFIED BY ANYONE. TO THE EXTENT ALLOWED BY LAW, ANY IMPLIED WARRANTIES, INCLUDING ANY IMPLIED WARRANTIES OF MERCHANTABILITY OR FITNESS FOR A PARTICULAR PURPOSE ARE LIMITED IN DURATION OF THE WRITTEN WARRANTY. CORRECTION OF NON-CONFORMITIES, IN THE MANNER AND FOR THE PERIODS OF TIME AS SET FORTH ABOVE, SHALL CONSTITUTE FULLFILLMENT OF ALL LIABILITIES OF THUNDERBIRD TO THE PURCHASER WHETHER BASED ON CONTRACT, NEGLIGENCE OR OTHERWISE.

THUNDERBIRD PRODUCTS SHALL NOT, UNDER ANY CIRCUMSTANCES, BE LIABLE FOR INCIDENTAL, CONSEQUENTIAL OR SPECIAL DAMAGES SUCH AS, BUT NOT LIMITED TO: DAMAGE TO OR LOSS OF OTHER PROPERTY OF EQUIPMENT, LOSS OF PROFIT, COST OF PURCHASED OR REPLACEMENT GOODS, CLAIMS OF CUSTOMERS OF THE PURCHASER, FAILURE TO WARN AND/OR INSTRUCT, OR LACK OF SEAWORTHINESS. THE REMEDIES OF THE PURCHASER SET FORTH HEREIN ARE EXCLUSIVE, AND THE LIABILITY OF THUNDERBIRD PRODUCTS SHALL NOT, EXCEPT AS EXPRESSLY PROVIDED HEREIN, EXCEED THE PRICE OF THE GOODS UPON WHICH SUCH LIABILITY IS BASED.

WARRANTY AND SERVICE

Some states do not allow limitations on how long an implied warranty lasts or the exclusions or limitations of incidental or consequential damages, so the above limitations or exclusions may not apply to you. This warranty gives you specific legal rights and you may have other legal rights, which vary from state to state.

THIS WARRANTY DOES NOT APPLY TO THE FOLLOWING:

1. Equipment and accessories not manufactured by THUNDERBIRD (engines, outdrives, generators, refrigerators/ice makers, air conditioning systems, instruments, controls, propellers, and optional electrical equipment are generally covered by warranties of the manufacturer supplying those units);
2. Installation of engines by persons other than THUNDERBIRD, or the misuse, neglect or lack of proper maintenance of the boat.
3. Components that have been altered.
4. Failure of any cockpit cover which has been used while trailering the vessel.
5. Windshield breakages or damage.
6. Cost for haul-out, launch, lift charges, towing, travel time charges and storage costs, and inconveniences or loss of time or income.
7. Any FORMULA boat that is modified for operation, in any contest of speed, acceleration, or endurance whatsoever.
8. Any guarantee whatsoever that a particular boat will achieve a certain level of performance relating to speed, range, fuel consumption or performance characteristics.
9. Any FORMULA boat that is used for commercial purposes. A vessel that is used 50% or more of the time for business or revenue-producing purposes is considered a commercial vessel.
10. Transportation charges on FORMULA boats, if any, to and from the dealer's service center or to and from the THUNDERBIRD manufacturing plant.

Due to a continuing program of product development and improvement, THUNDERBIRD reserves the right to change FORMULA specifications, features and prices without notice.

NOTE: In addition to the Thunderbird Limited Warranties, ***Formula Guard Extended Protection*** provides transferable supplemental coverage for the propulsion system and many components and accessories on each Formula boat for five years from the date of delivery to the original retail purchaser. See the Formula Guard owner's manual for specific coverage parameters.

The manuals and warranty information for Formula, Formula Guard and major components can be found in the OWNER INFORMATION BINDER included with your boat. For additional information on individual warranties, contact your selling dealer.

SUN SPORT

FLOAT PLAN

Copy this page and fill out the copy before boating. Leave the filled out copy with a reliable person who can be depended upon to notify the USCG, or other rescue organization, should you not return as scheduled. Do not file this plan with the USCG.

Name _____ Telephone _____

Description of Boat: Type _____ Color _____ Trim _____

Registration Number _____

Length _____ Name _____ Make _____

Other Info. _____

Persons Aboard: Name _____ Age _____ Address & Telephone _____

Engine Type: _____ HP _____

No. of Engines: _____ Fuel Capacity: _____

Survival Equipment:

PFDs _____ Flares _____ Mirror _____

Smoke Signals _____ Flashlight _____ Food _____

Paddles _____ Water _____ Anchor _____

Raft or Dinghy _____ EPIRB _____

Radio: Yes _____ No _____ Type _____ Freq _____

Destination _____ Est. Time of Arrival _____

Expect to Return By _____

Auto Type _____ License No. _____ Parked _____

If not returned by _____ call the Coast Guard, or _____

(Local Authority). Coast Guard Telephone Number: _____

Local Authority Telephone Number: _____

SUN SPORT

USEFUL INFORMATION

Store this information in a safe place other than your boat.

Owner _____

Home Port _____

Boat Name _____

Selling Dealer _____

Port Ignition Key Number _____ Starboard Ignition Key Number _____

Registration Number _____ State _____

Hull Serial Number _____ Warranty Registration Date _____

Engine Make and Model Number _____

Port Engine Serial Number _____

Starboard Engine Serial Number _____

Port Drive Serial Number _____

Starboard Drive Serial Number _____

Propeller Size _____

Generator Make and Model Number _____ Serial Number _____

VHF Radio Make and Serial Number _____ Serial Number _____

GPS Make and Model Number _____ Serial Number _____

Radar Make and Model Number _____ Serial Number _____

TRANSFER FORM

To transfer the Formula Guard Limited Warranty to the second owner, complete this form and submit it to the Administrator. Please retain copies for your records. The new owner will receive an Identification Card reflecting their customer information.

Please allow 90 days for transfer processing.
Claims are eligible for coverage anytime during the processing period.

Warranty Holder _____ Limited Warranty Number _____

Transfer To:

Customer _____ Date of Sale _____

Address _____

City _____ State _____ Zip _____

Telephone _____ Business Telephone _____

I understand that I am entitled to only the coverage listed in the Formula Guard Limited Warranty booklet. I agree to contact the Administrator (1-800-867-7626) immediately, if I do not receive the Identification Card, which validates this Formula Guard Limited Warranty, within 90 days of the above date.

Transferee Signature

Complete the form and fax to:
Interstate National Dealer Services, Inc.
(516) 745-1986

SUN SPORT